

教科書文庫  
4  
710  
41-1944  
2000014591

広島大学図書  
2000014591

中等學校教科書株式會社



40722

教科書文庫

4
710
41-1944
2000.0 14591

**Kodak Color Control Patches**

Blue Cyan Green Yellow Red Magenta White 3/Color Black

**Kodak Gray Scale**

A 1 2 3 4 5 6 M 8 9 10 11 12 13 14 15 B 17 18 19

© Kodak, 2007 TM: Kodak

375.9  
Chu 20

資料室

教科書文庫
4
710
41-1944
2000014591

文部省檢定済  
昭和十九年一月十日 中學校・實業學校藝能科用

# 圖畫

2

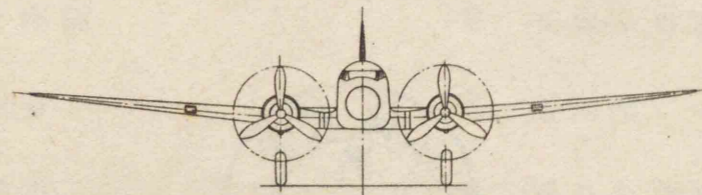

広島大学図書

2000014591



中等學校男子用



目 次

1 形體と明暗	2	9 實測製圖	30
2 文字の形體	6	10 鑑賞(工藝)	32
3 線描と濃淡	8	11 單化描寫	38
4 讀圖と臨圖	10	12 機械の外形	40
5 鑑賞(繪畫)	14	13 展開圖	42
6 細密描寫	20	14 器具の創案	46
7 寫景練習	22	15 鑑賞(建築)	48
8 色感訓練	26		

1 形體と明暗 (一)

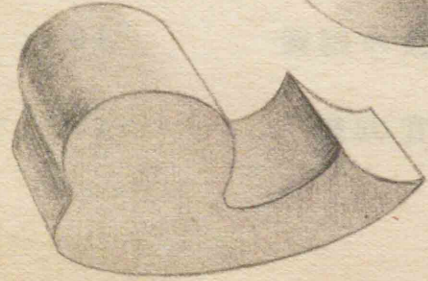
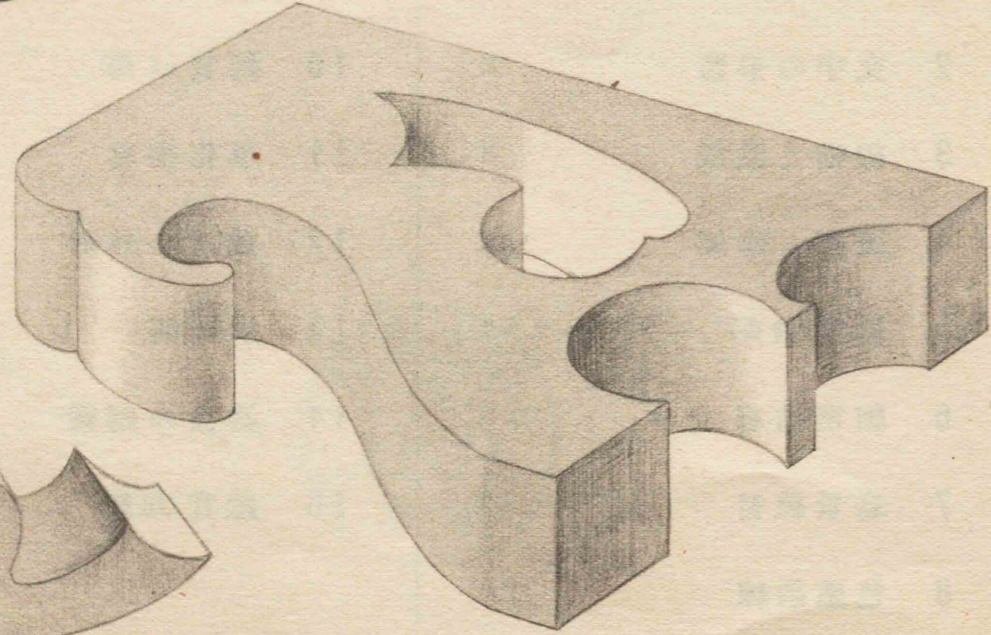
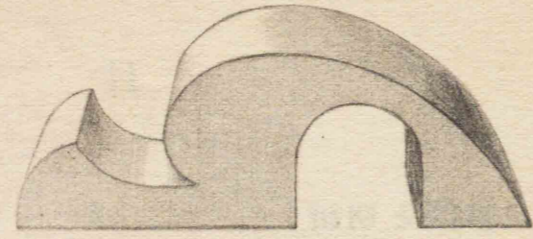
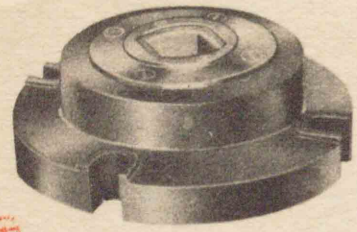

東京美術大学  
図工部

1 形體と明暗 (二)

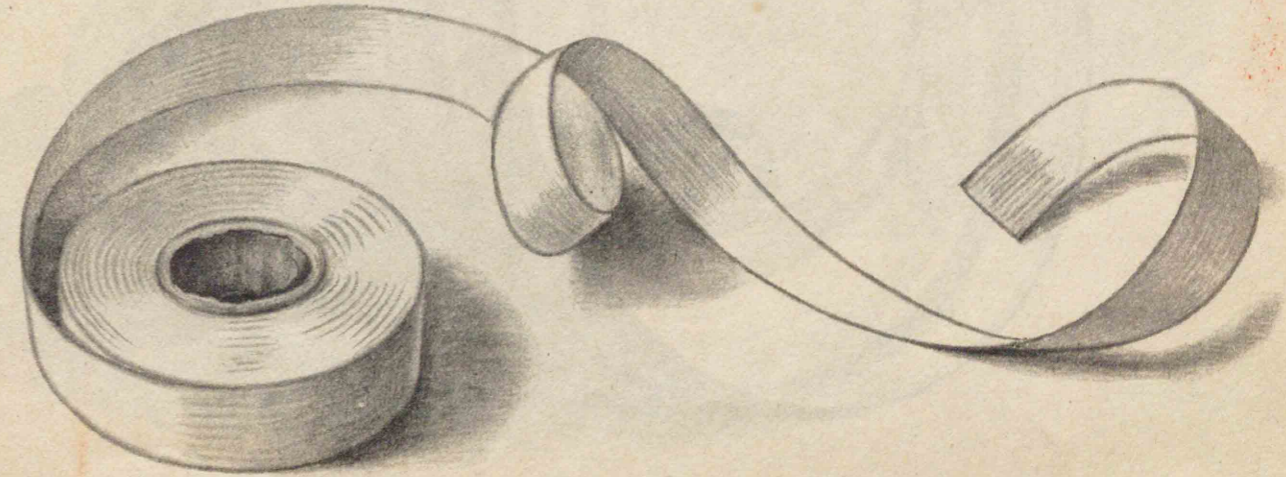
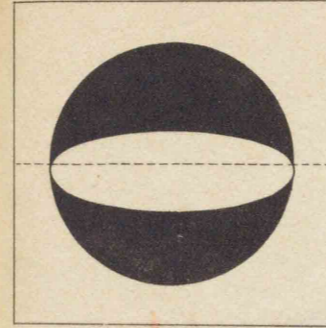

1 形體と明暗 (三)

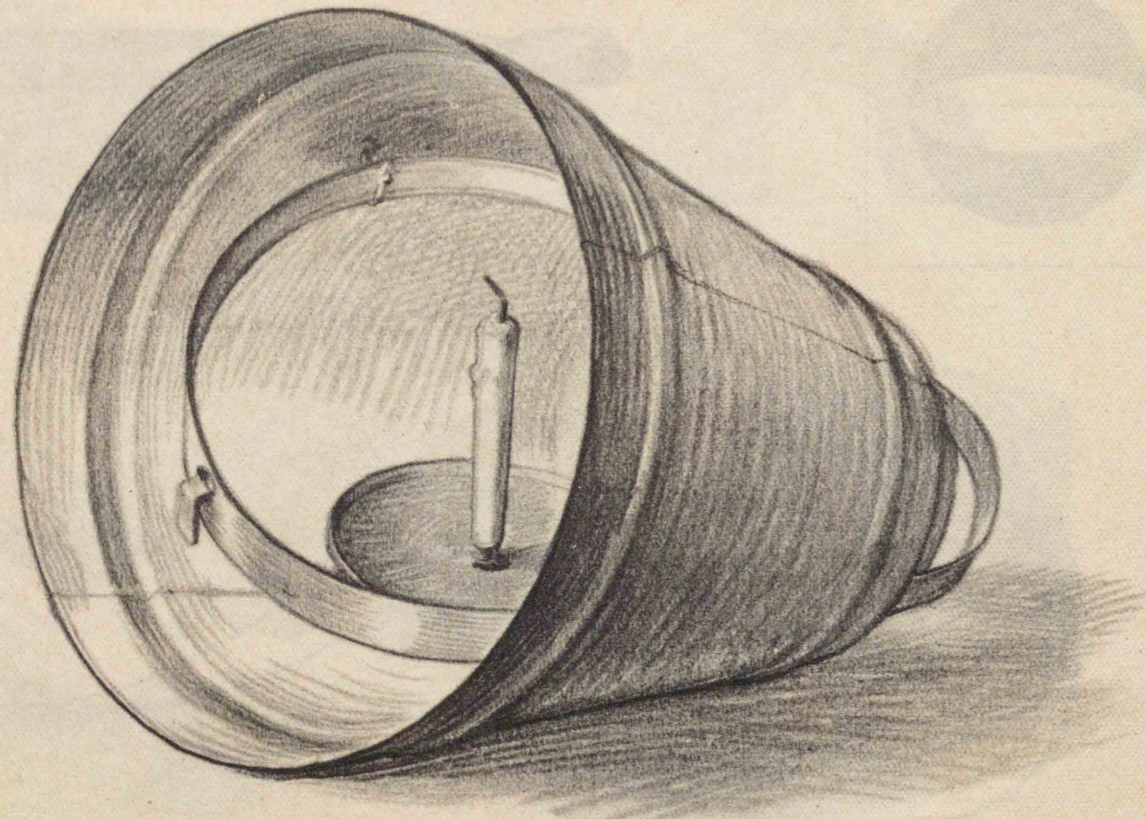

1 形體と明暗 (四)

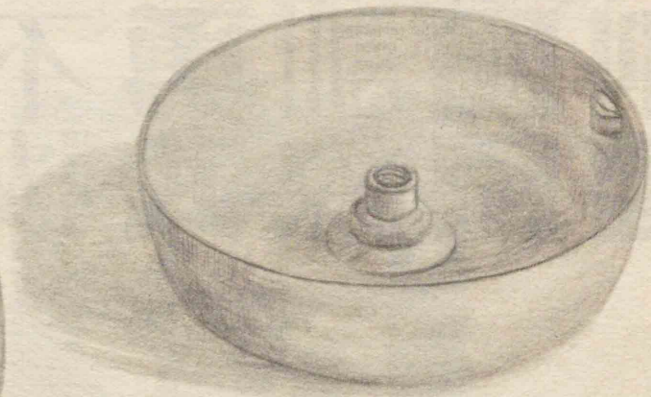
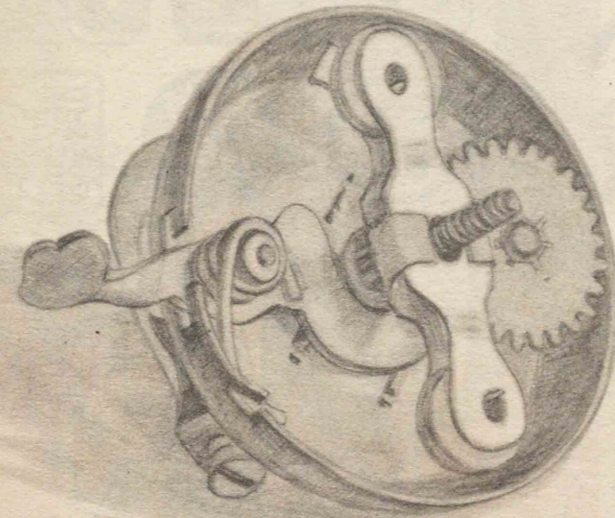

2 文字の形體 (一)

質實剛健 率先躬行 千磨訓練 忠孝勇武 牢固不拔

1 2 3 4 5  
6 7 8 9 0



活字の大小

初	一	二	三	四	五	六	七	6	8	9	12	18	24	30	36
號	號	號	號	號	號	號	號	ポイント	ポイント	ポイント	ポイント	ポイント	ポイント	ポイント	ポイント
圖畫	圖畫	圖畫	圖畫	圖畫	圖畫	圖畫	圖畫	圖畫	圖畫	圖畫	圖畫	圖畫	圖畫	圖畫	圖畫

2 文字の形體 (二)



われら つとめん

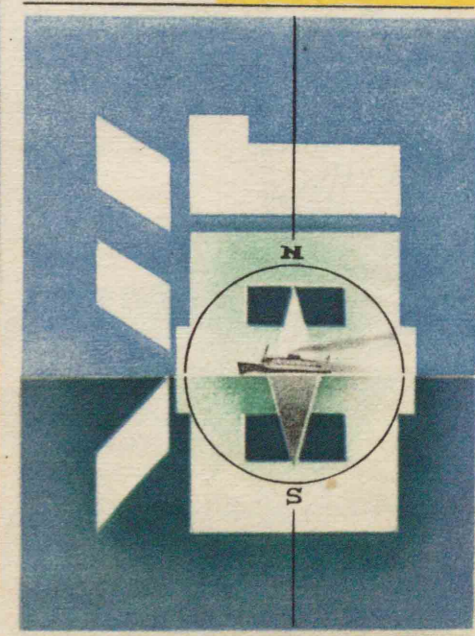

3 線描と濃淡(一)

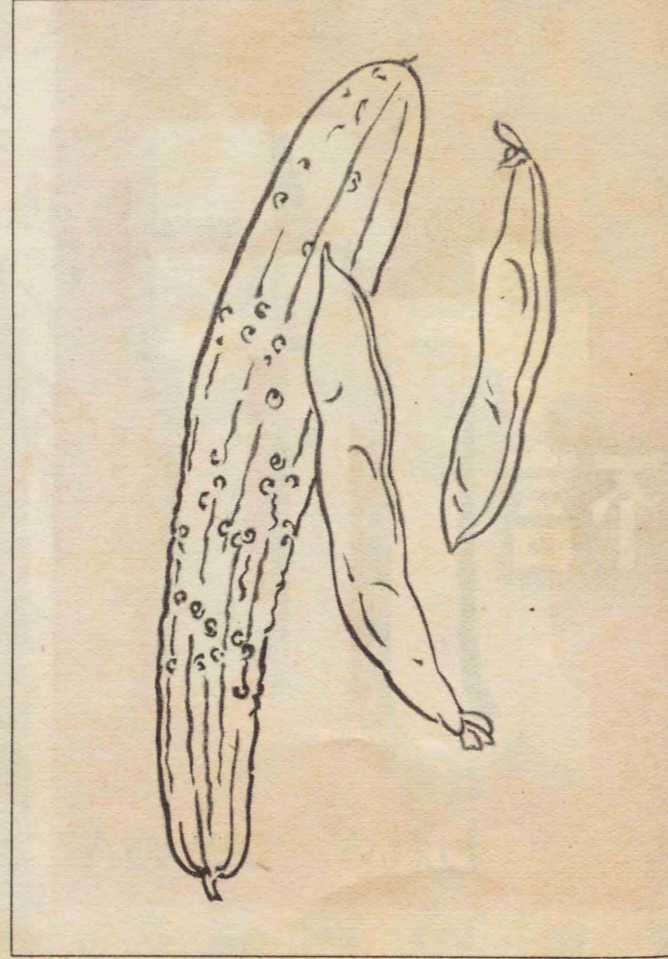
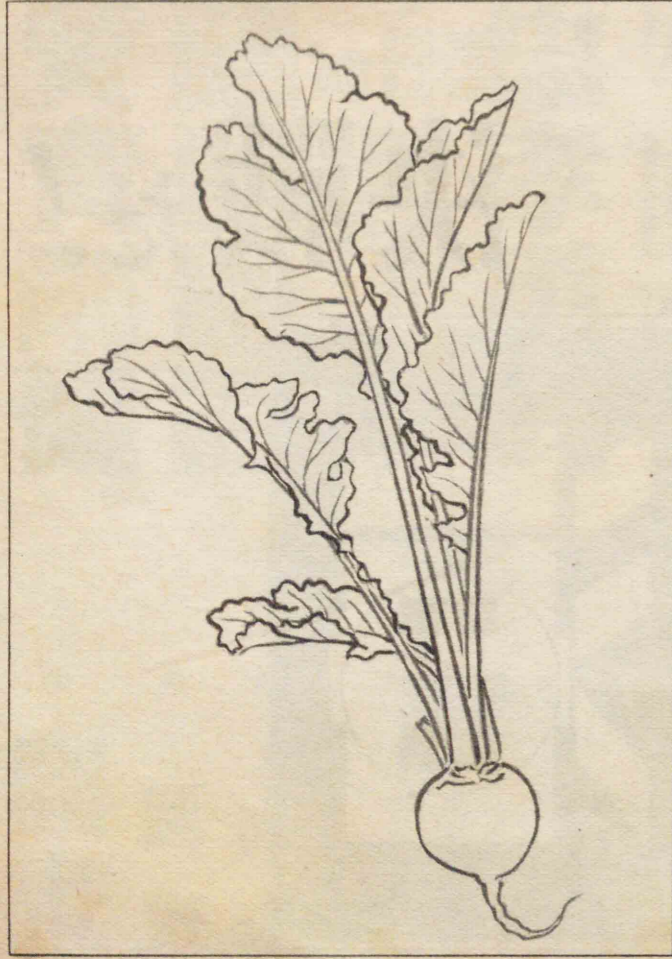

3 線描と濃淡(二)



4 讀圖と臨圖 (一)

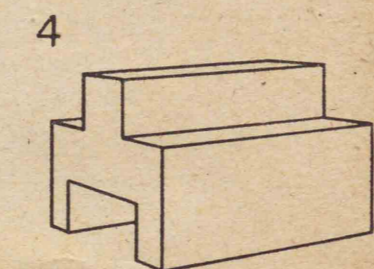
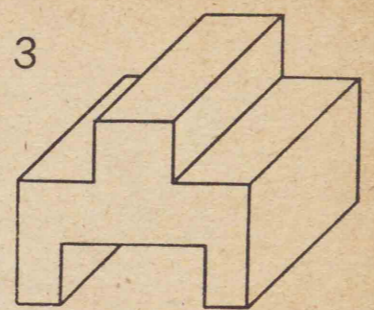
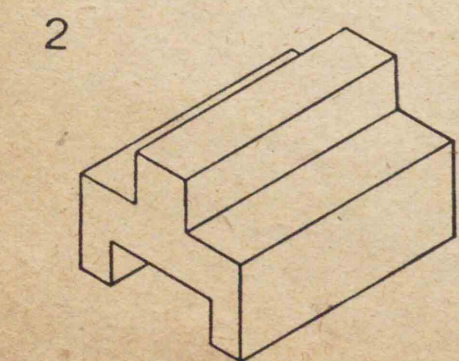
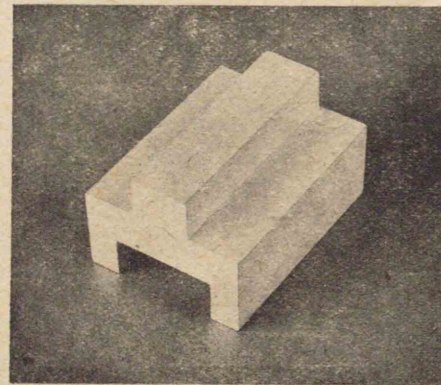
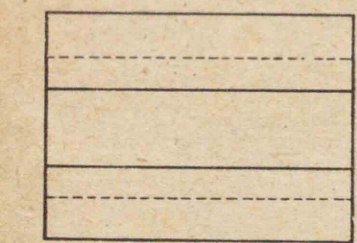
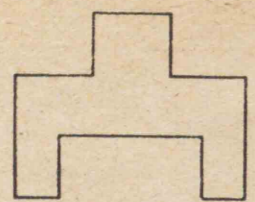
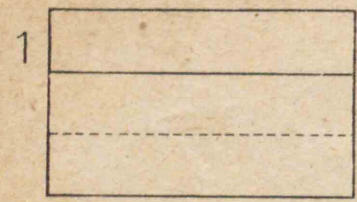

1 正投影圖  
2 等角投影圖

3 傾斜投影圖  
4 透視圖

4 讀圖と臨圖 (四)

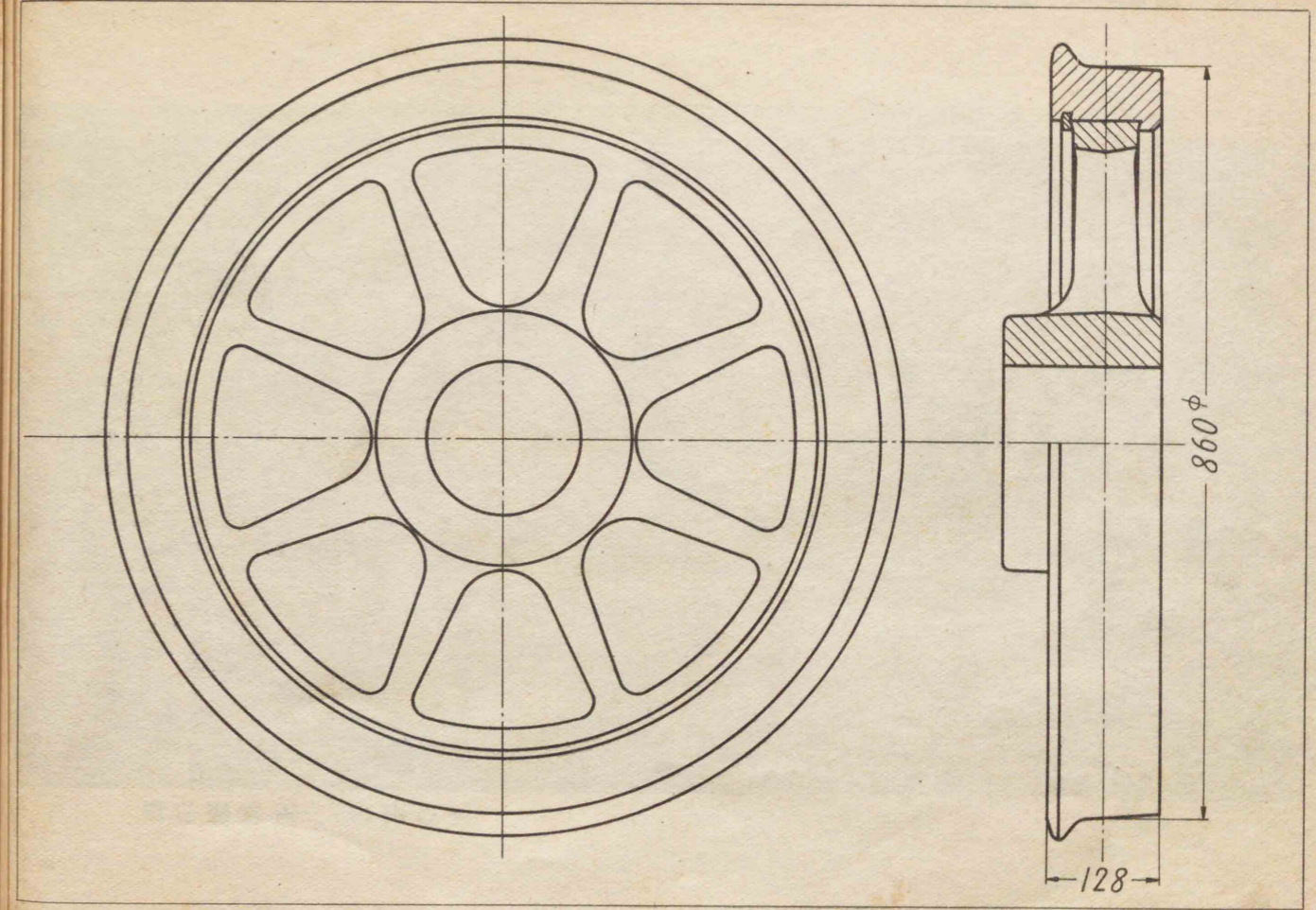





天心先生 下村觀山筆



悲母觀音 狩野芳崖筆

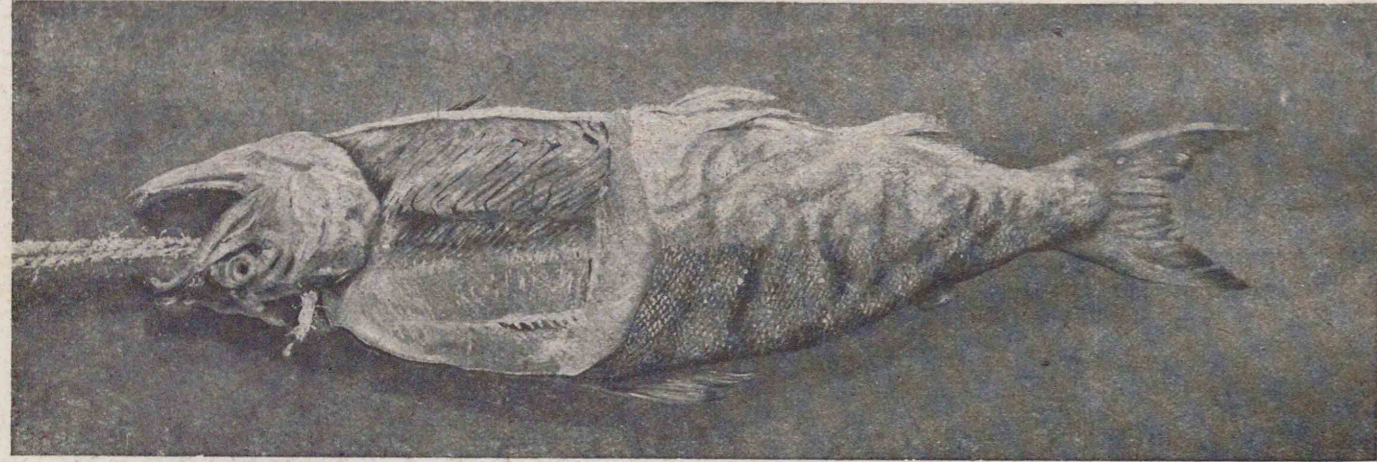

鮭 高橋由一筆



百合 黒田清輝筆



海棠樹 滿谷國四郎筆



初冬晚暉 岡田三郎助筆

6 細密描寫 (一)



6 細密描寫 (二)

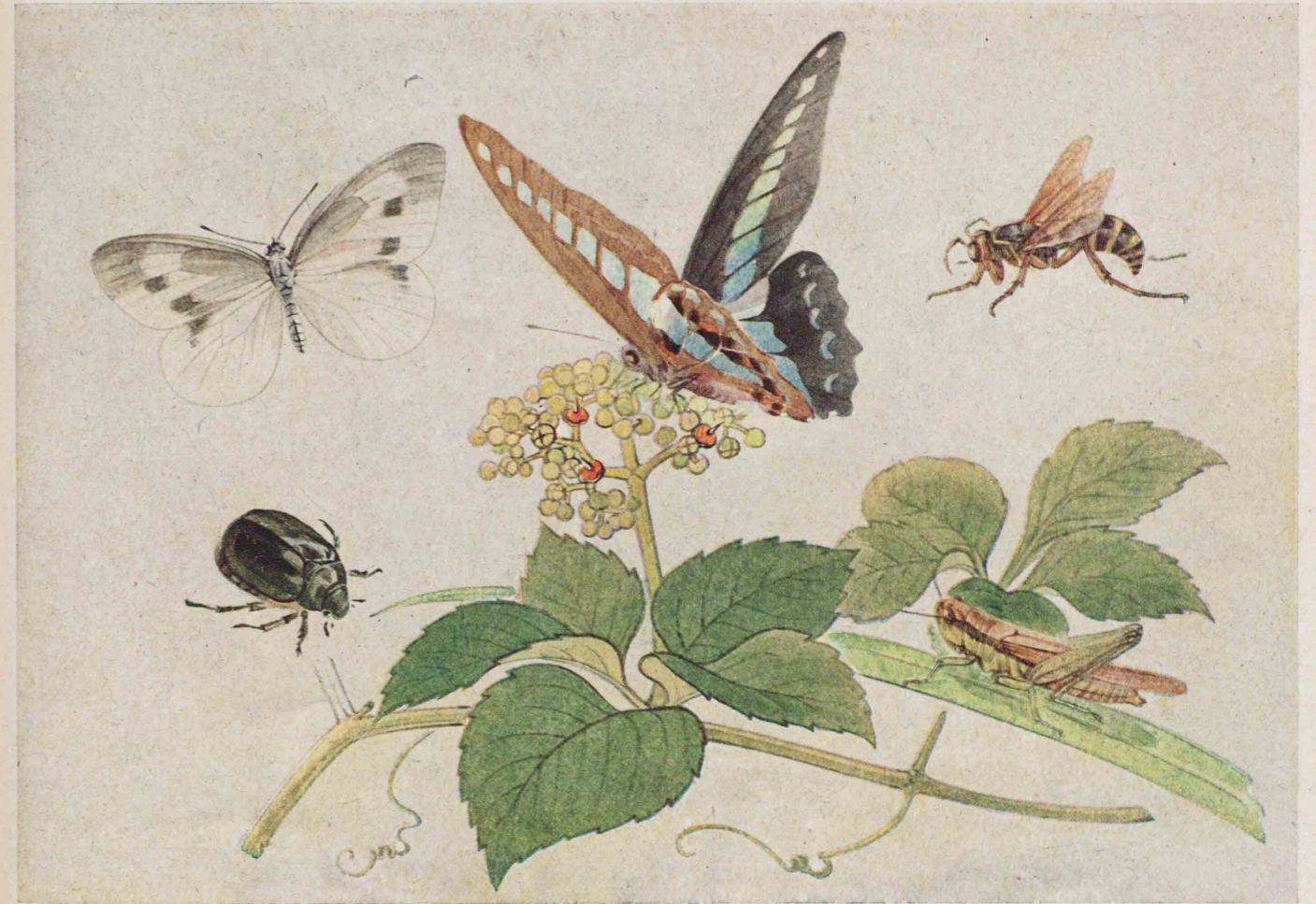

7 寫景練習 (一)



7 寫景練習 (二)



7 寫景練習 (三)

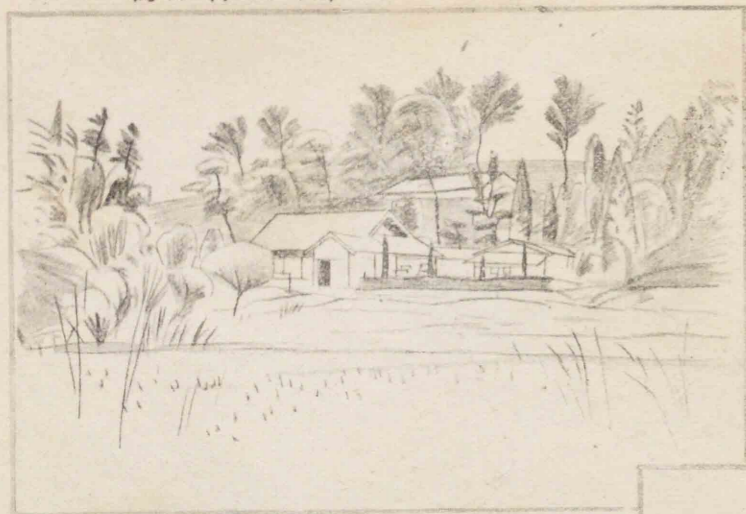

7 寫景練習 (四)



8 色感訓練 (一)

明度を主とした色の分類

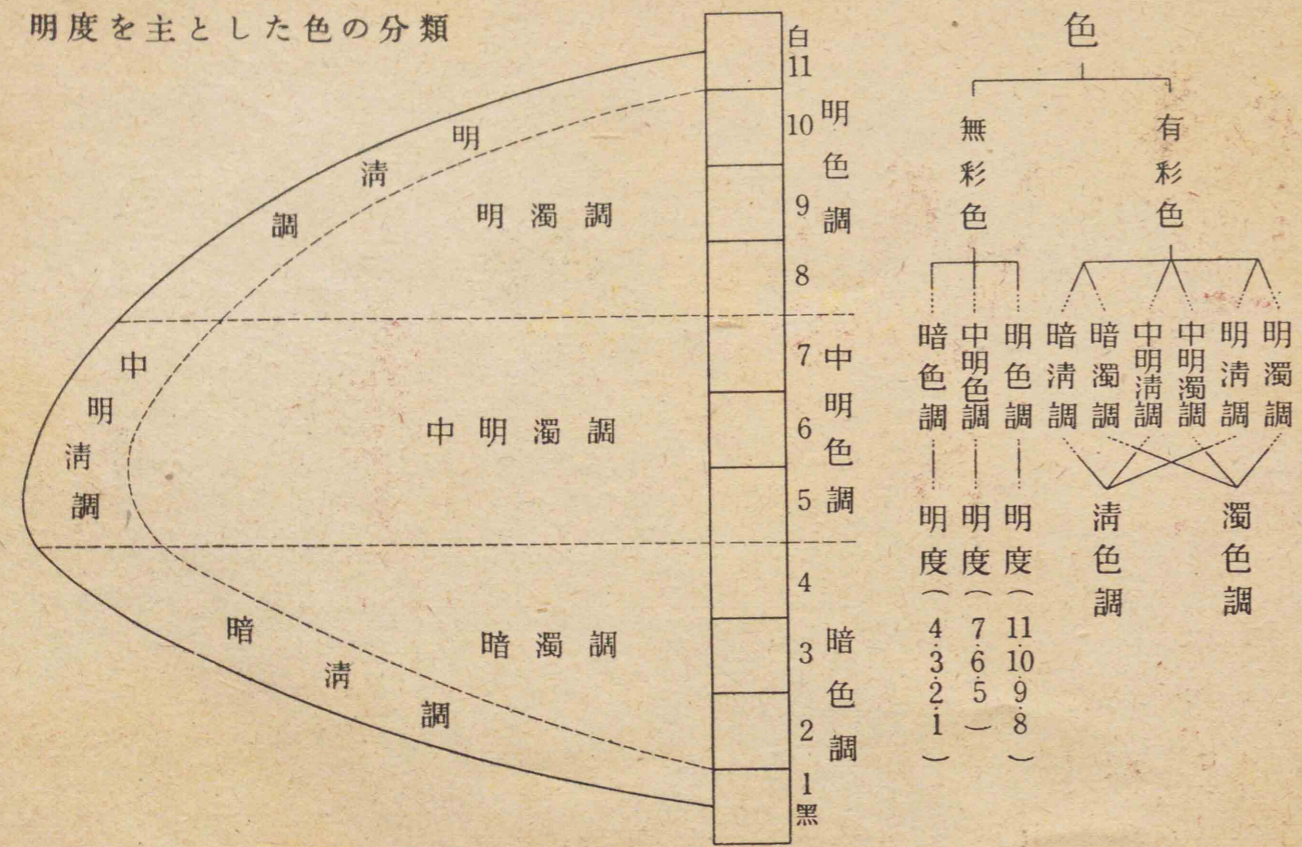

8 色感訓練 (二)

色相による色の分類



8 色感訓練 (三)

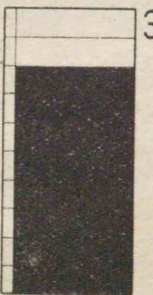
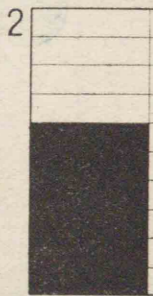
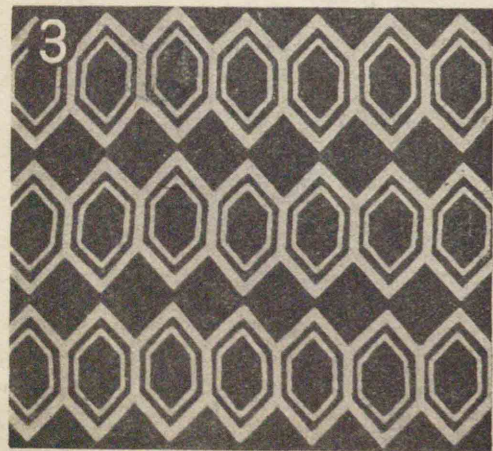
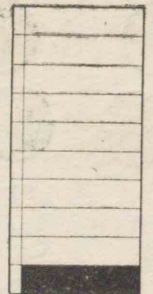
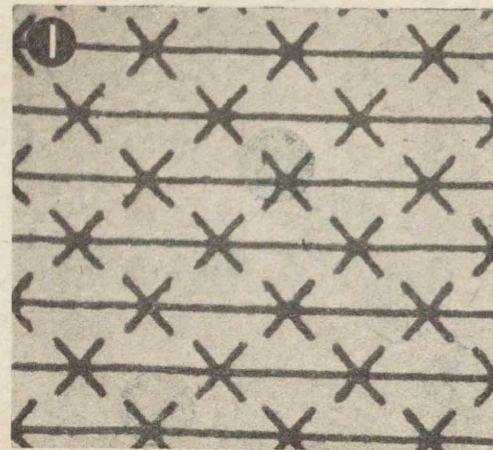

8 色感訓練 (四)

配色 同色相



近距離色相



遠距離色相

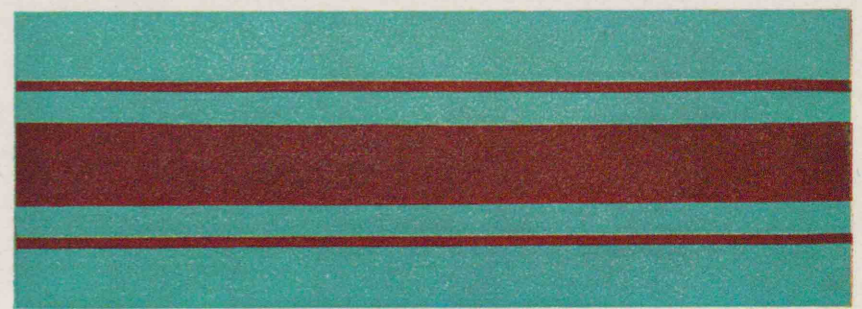
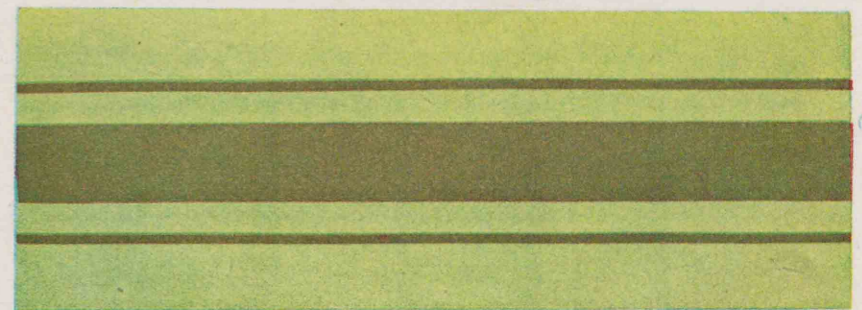
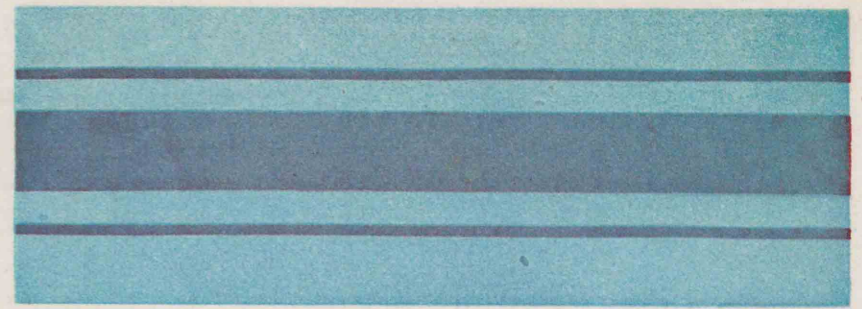
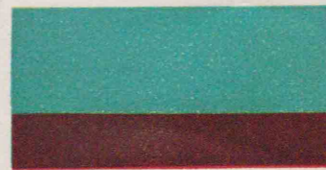



戶棚

9 實測製圖(一)

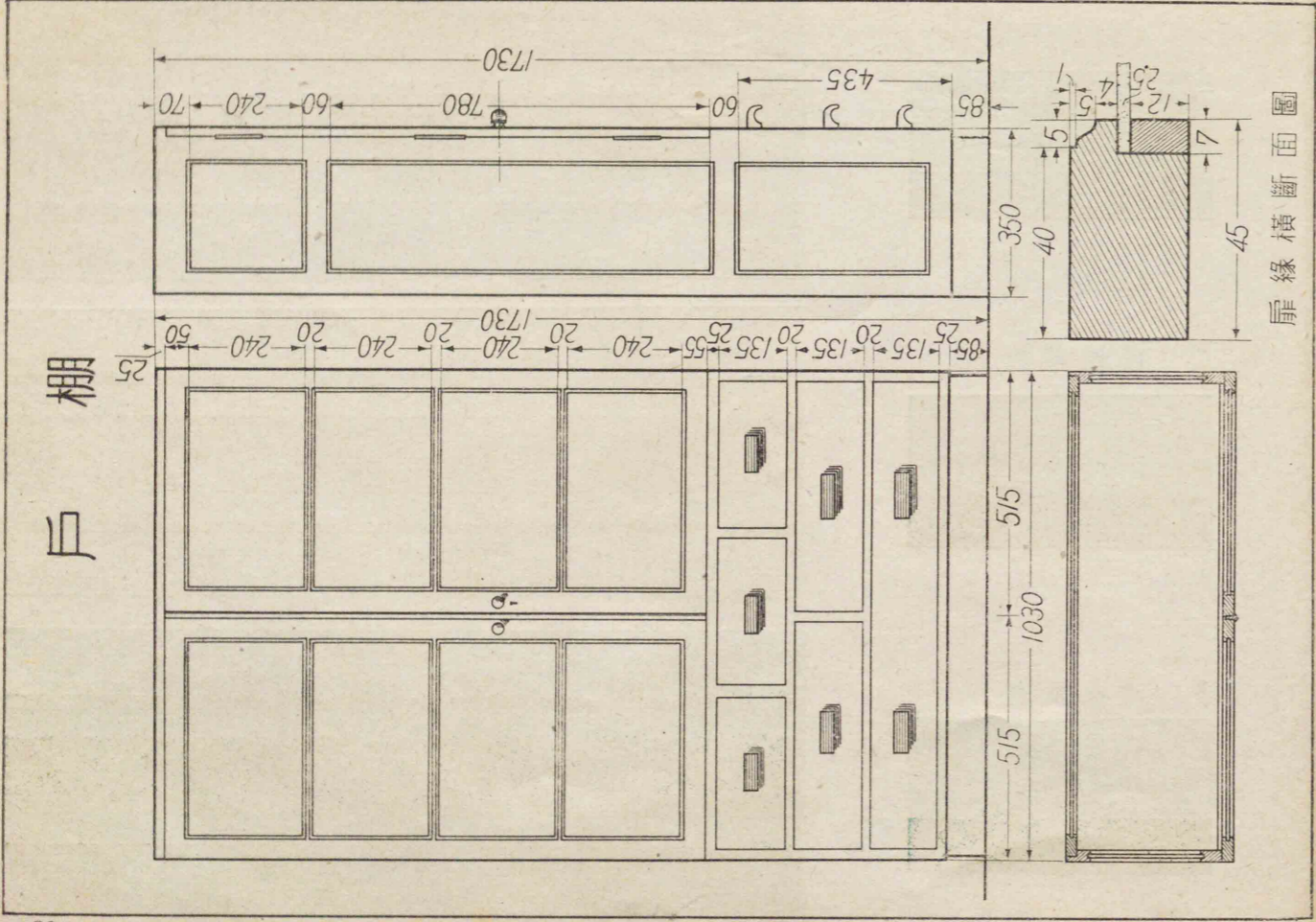

扉緣橫斷面圖

戶棚

9 實測製圖(二)

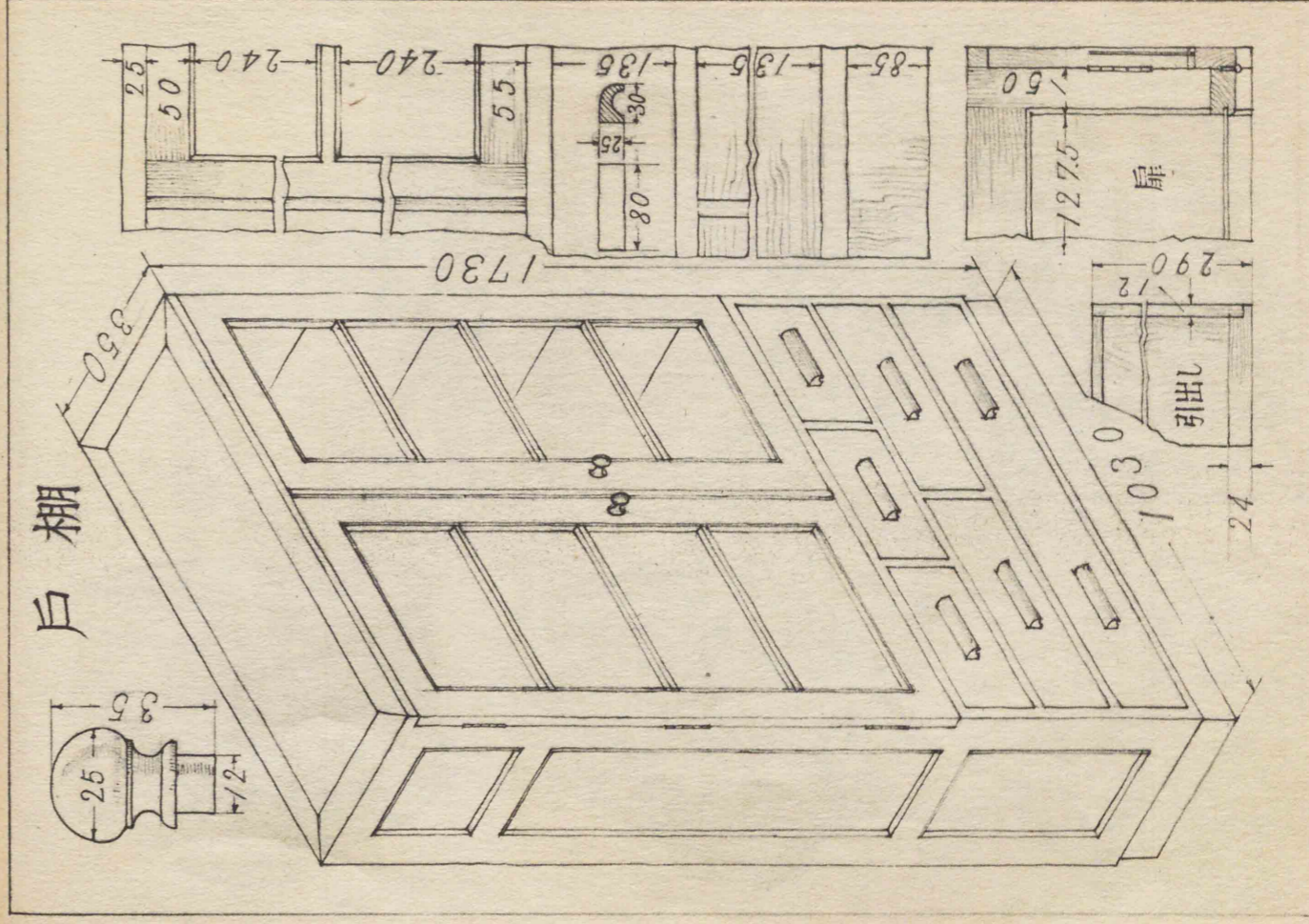

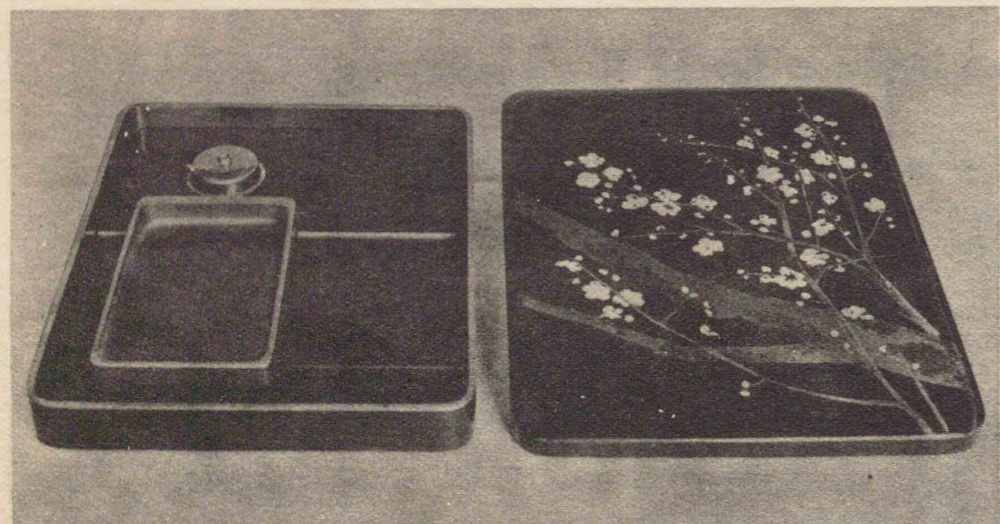

漆器・陶器

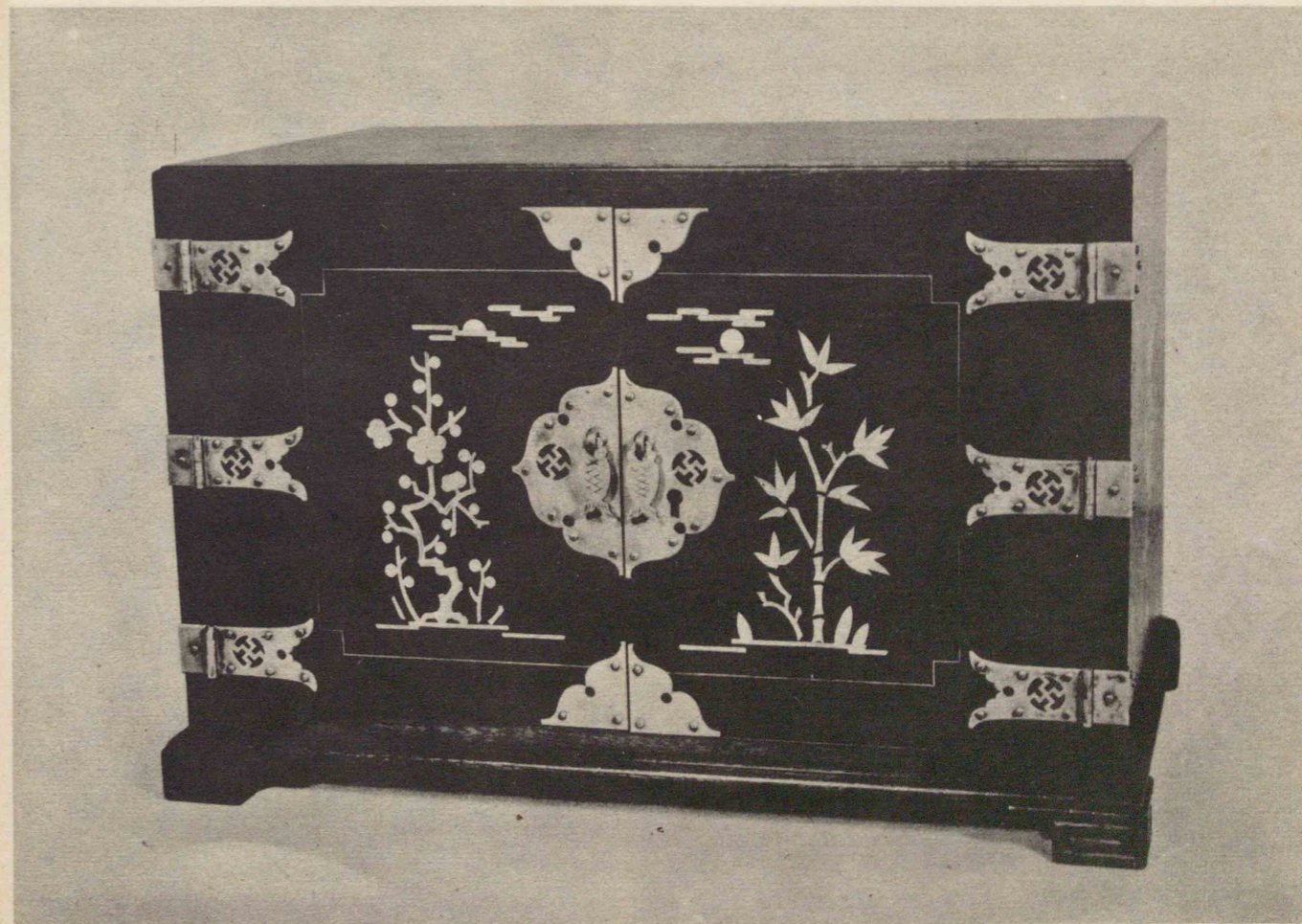

木工品 33

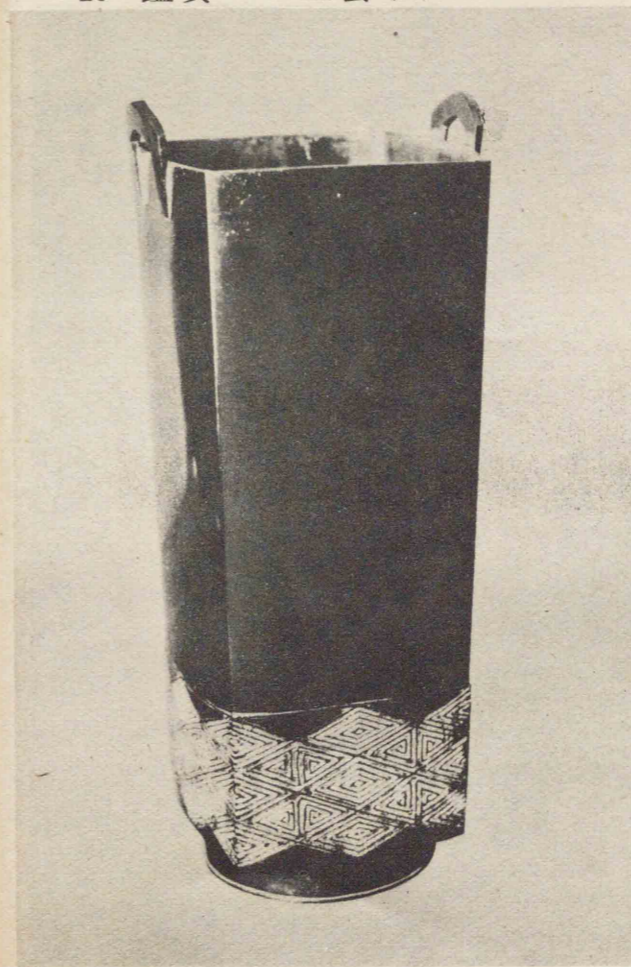

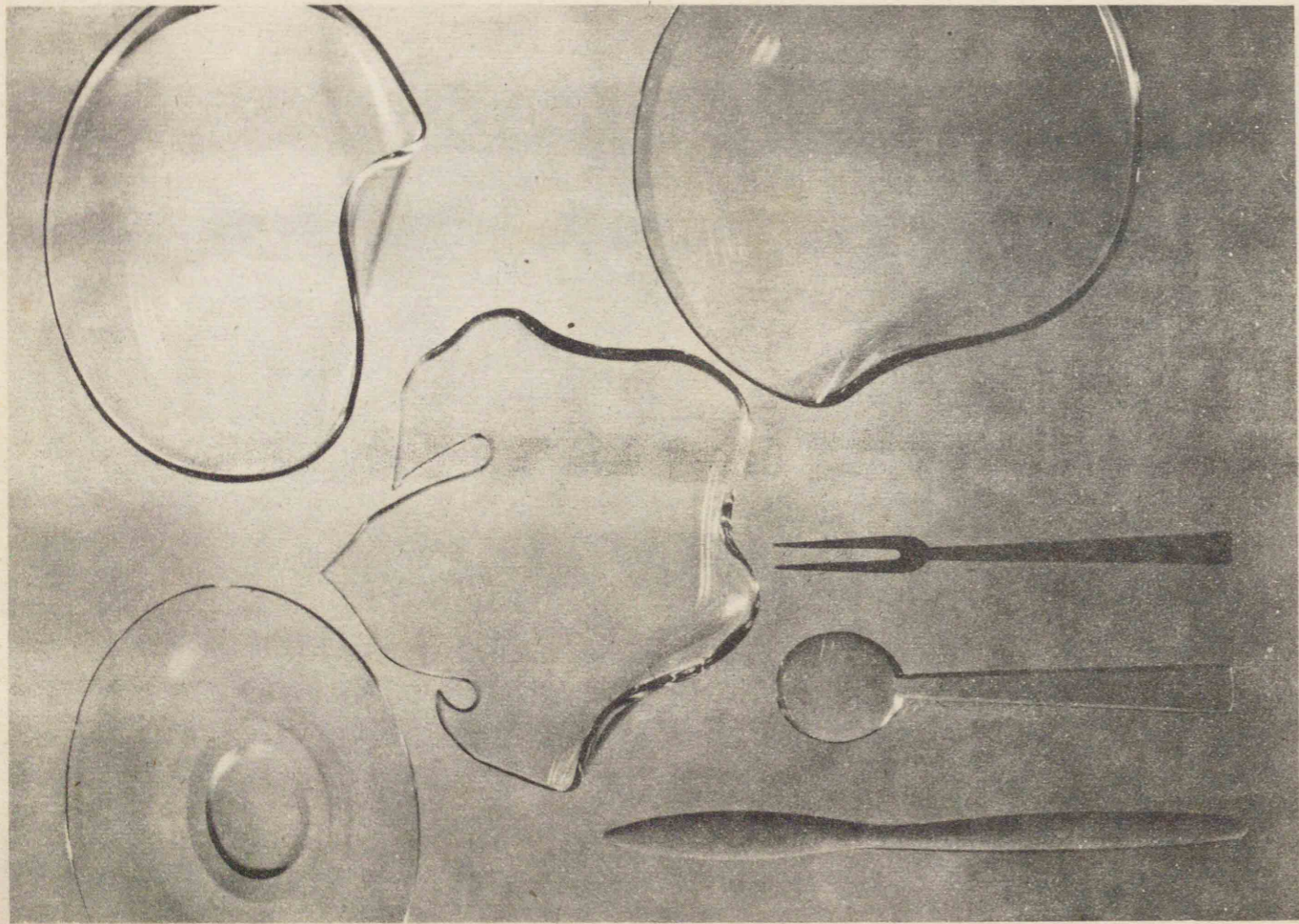

合成樹脂品

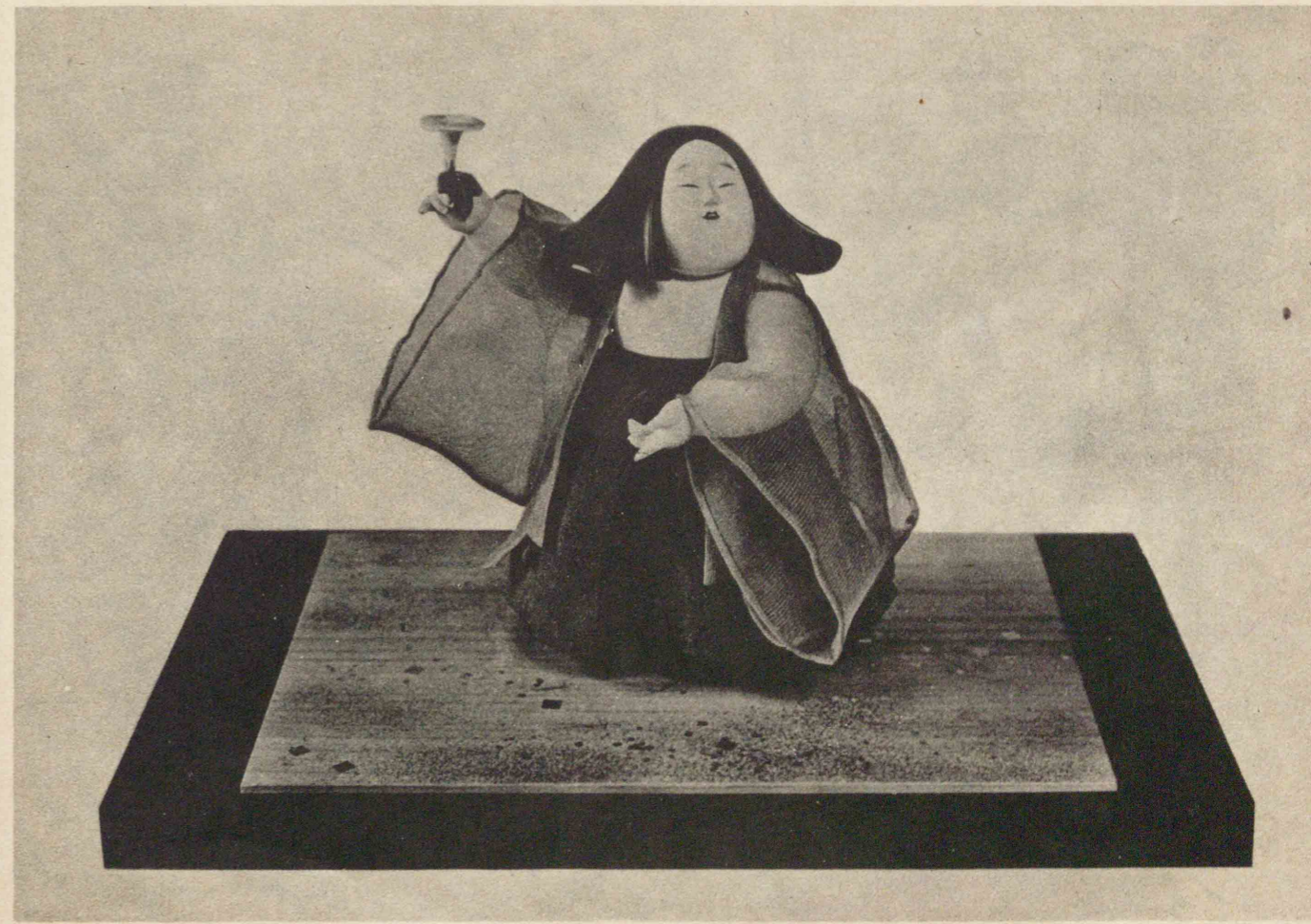

11 單化描寫 (一)



11 單化描寫 (二)



12 機械の外形 (一)

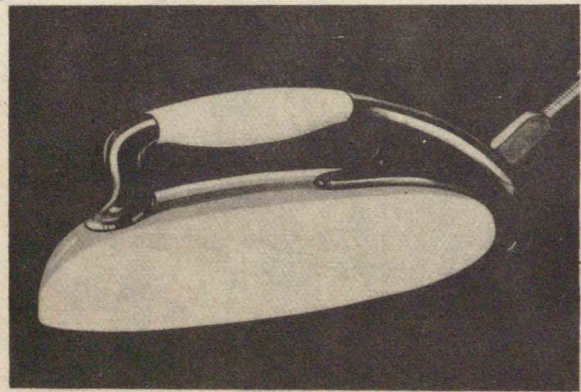
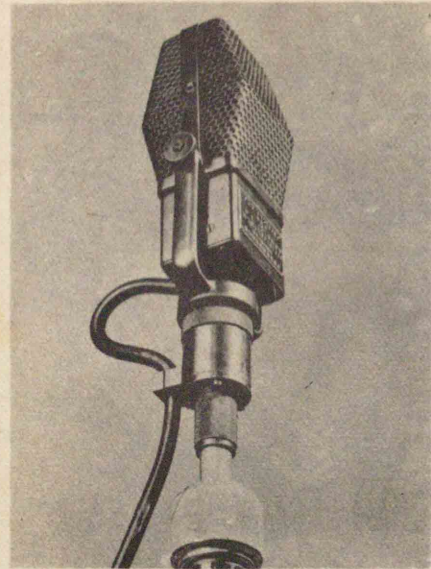

12 機械の外形 (二)

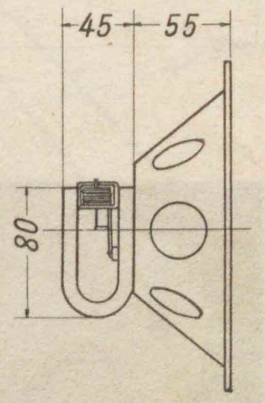
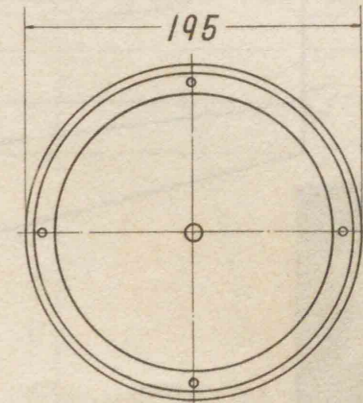
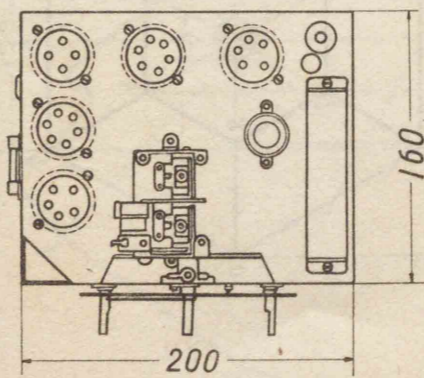
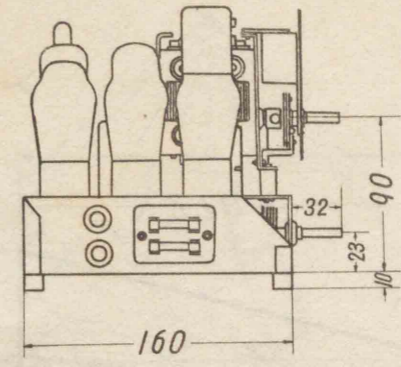
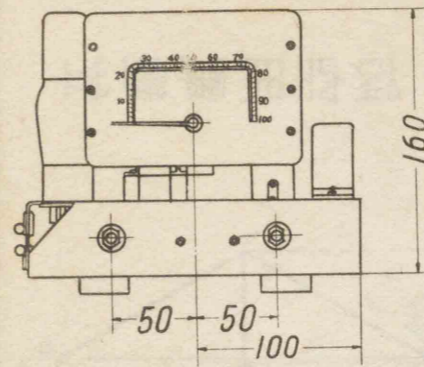

上圖のラジオ受信機を組み合はせ、その外箱を美しい形にまとめ、それを見取圖にか

いてみよう。寫真はその一例である。

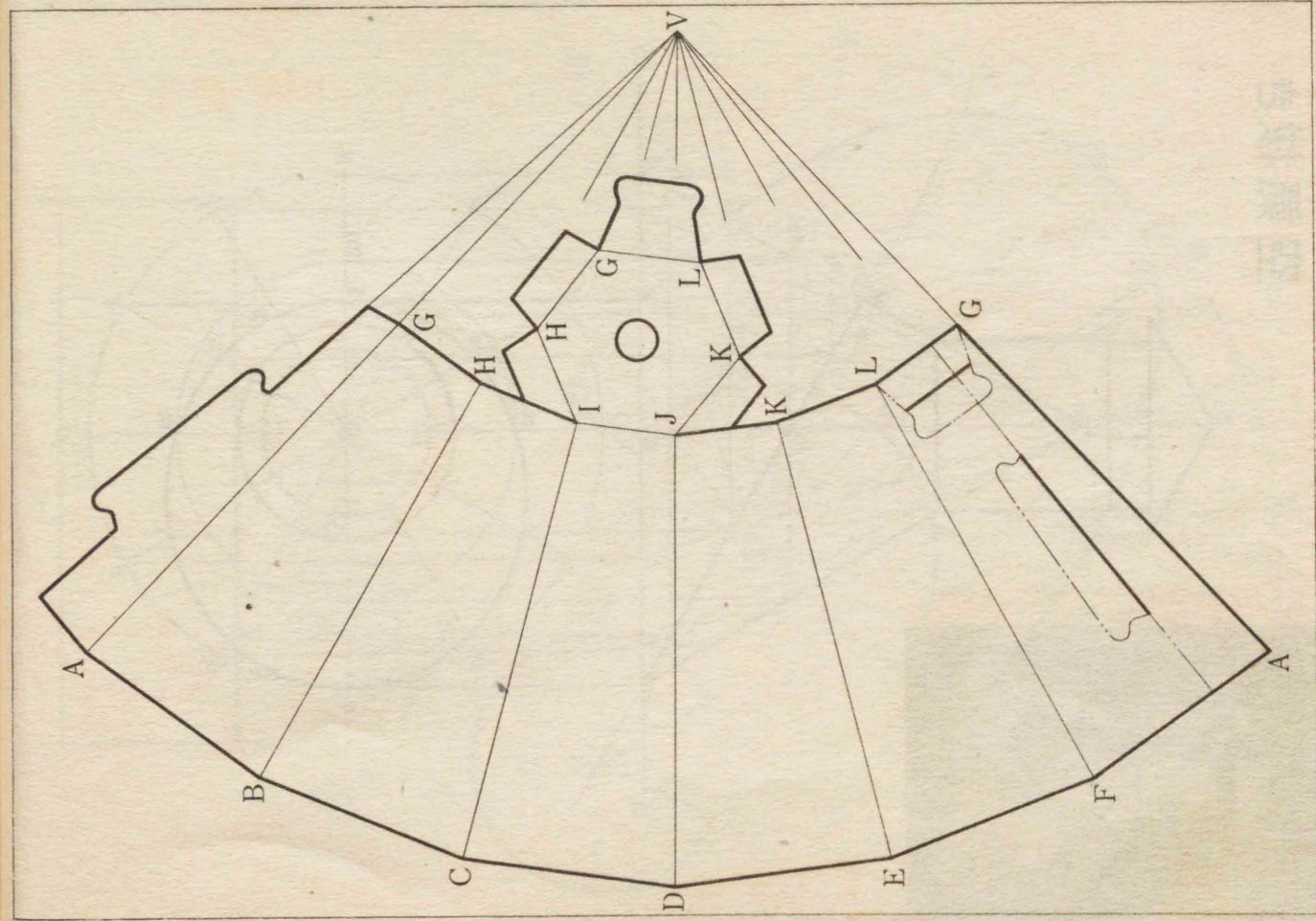
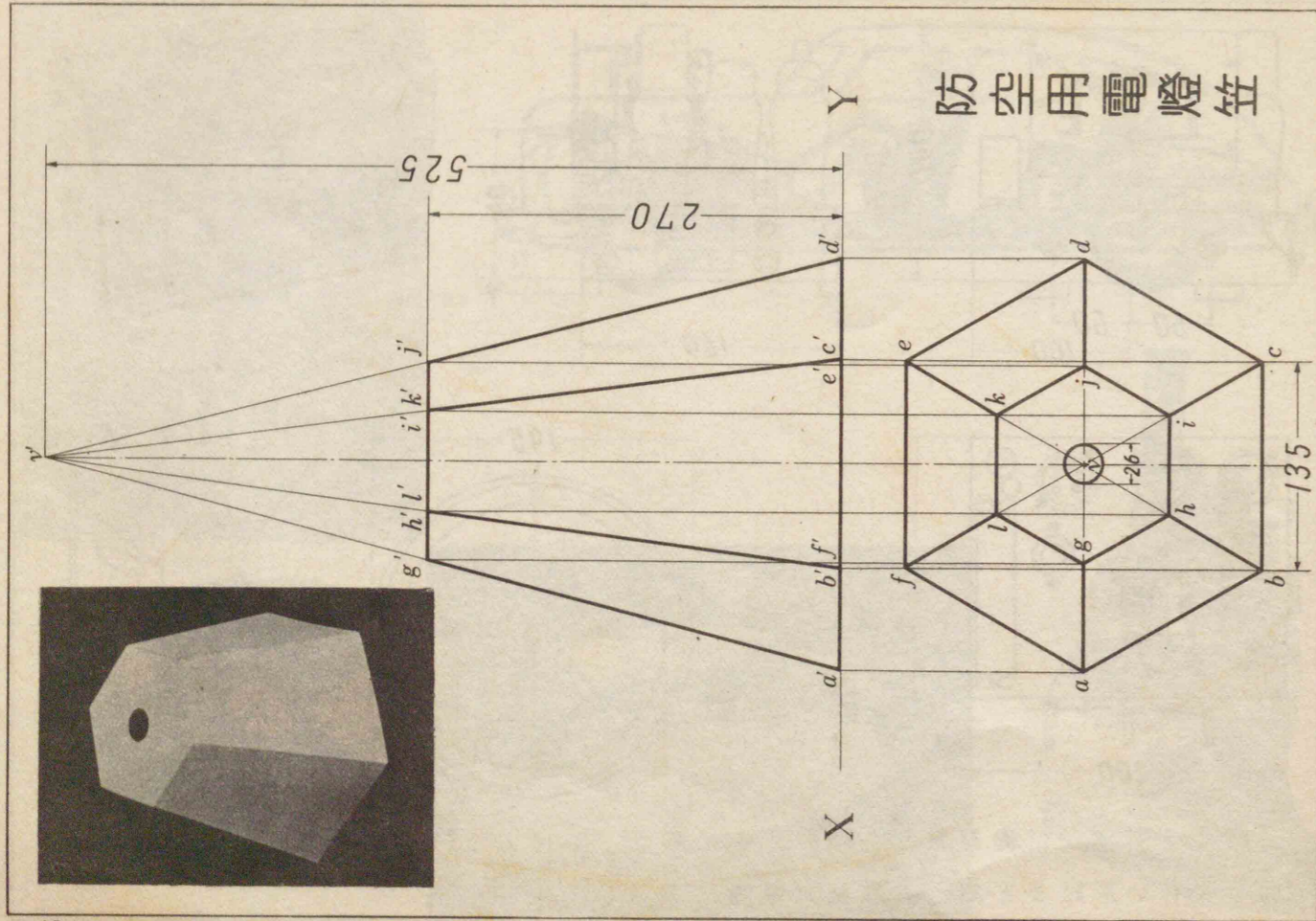

空氣抜き

13 展開圖(三)

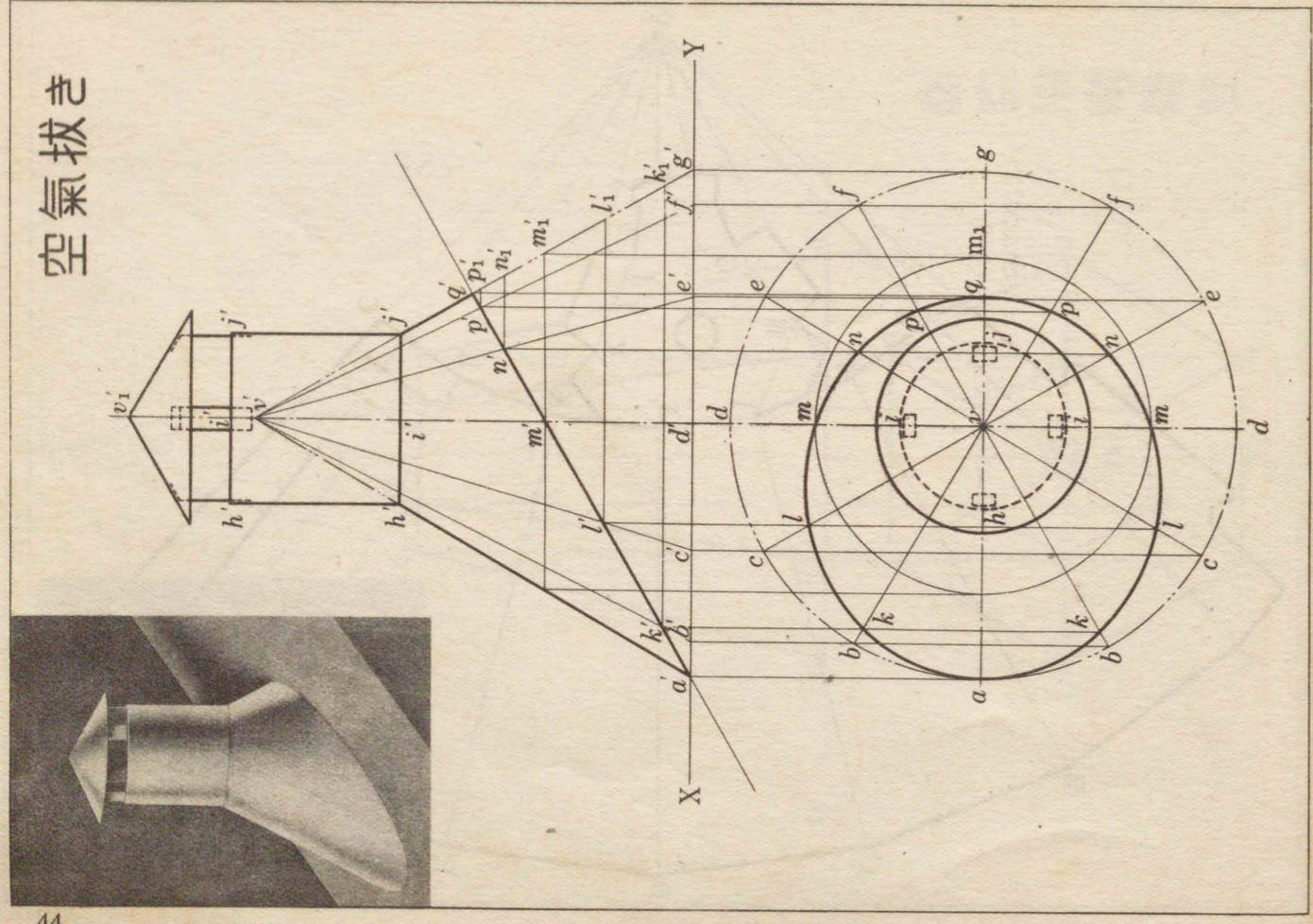

13 展開圖(四)

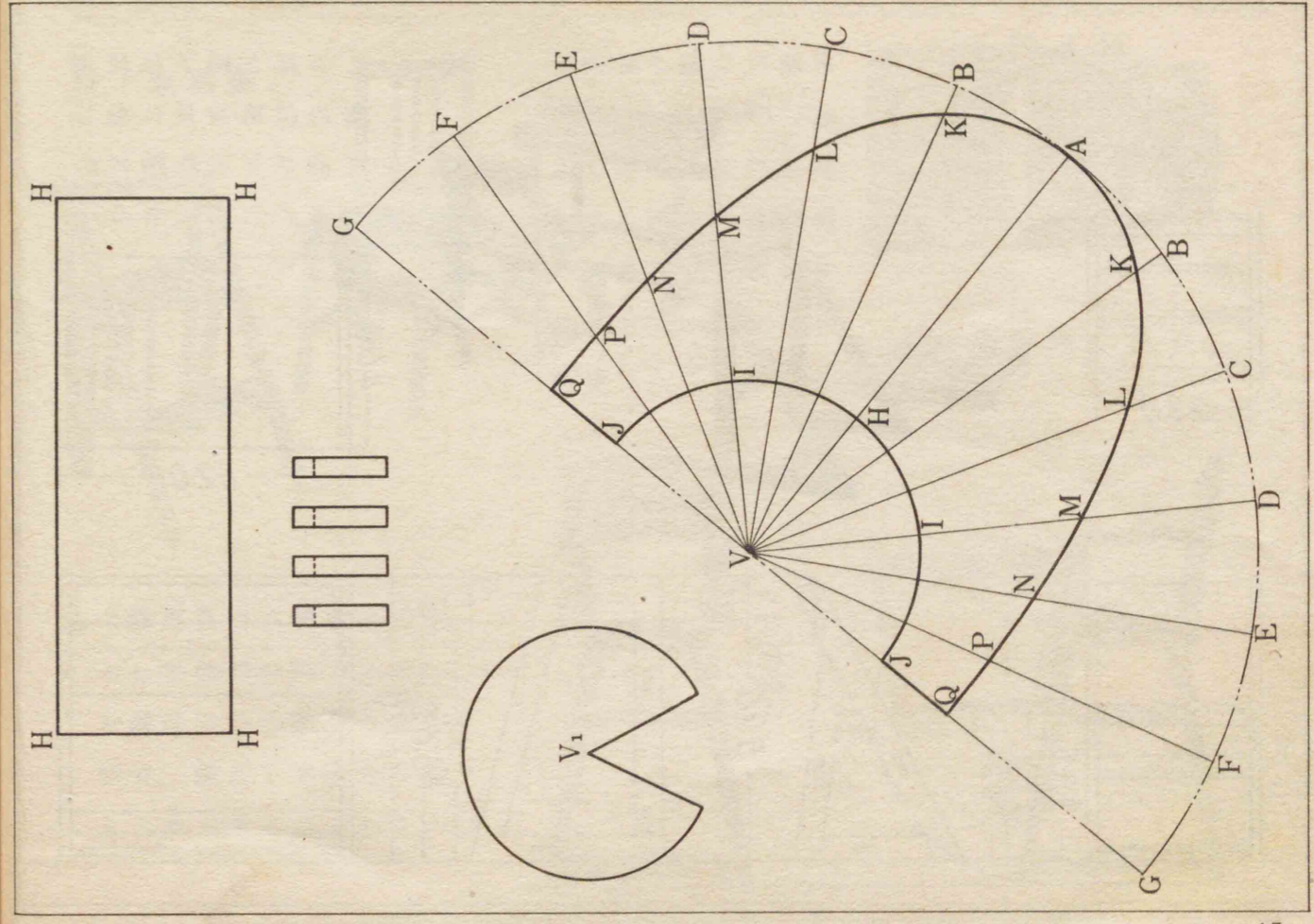



14 器具の創案 (一)

机と椅子

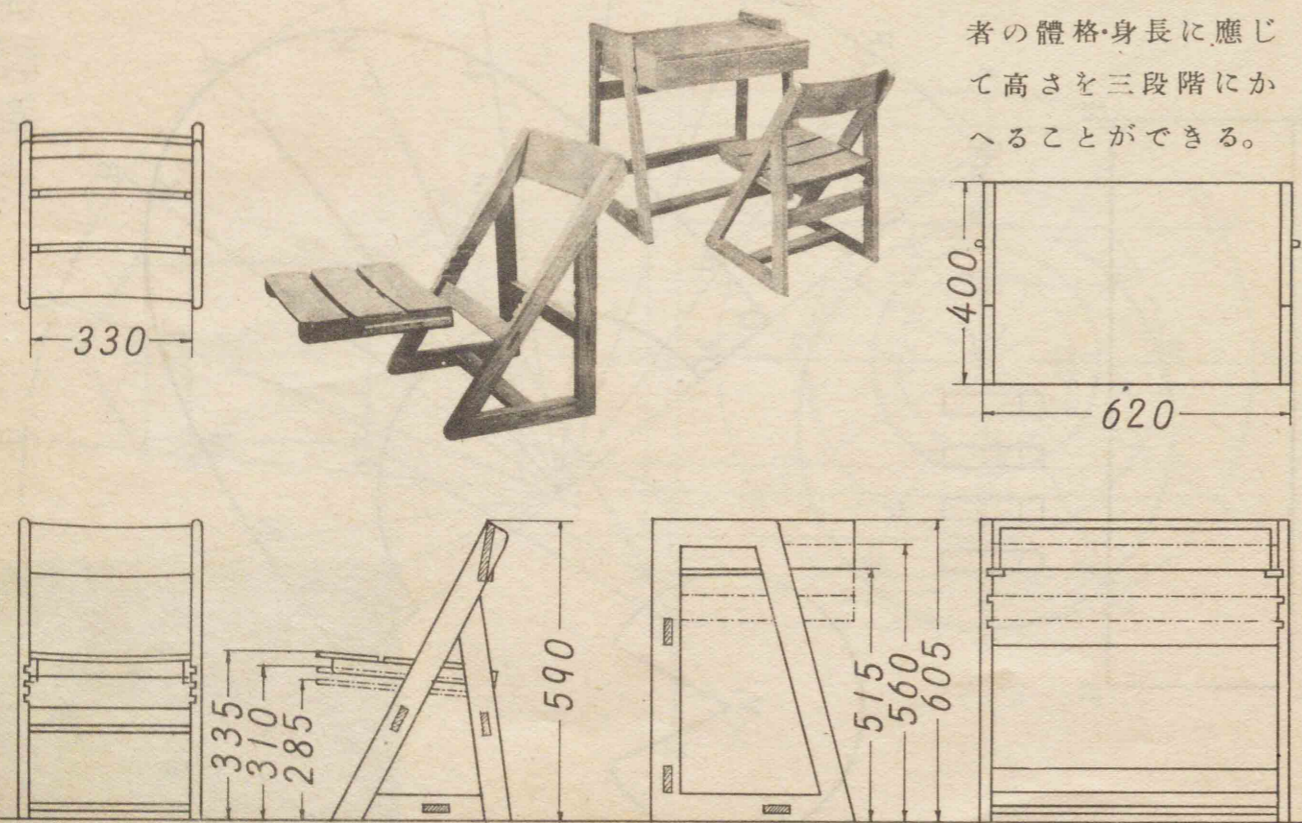

この机と椅子は使用者の體格・身長に應じて高さを三段階にかへることができる。

14 器具の創案 (二)

椅子兼踏臺



子供用小椅子は通常は210mm(0.693尺)の高さで遊戯に使ひ、食事をする時などは前面の遊戯板を下の方に廻し、560mm(1.848尺)の高さにして使用する。

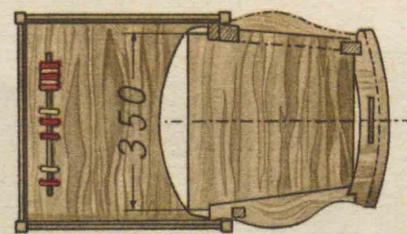

子供用小椅子

上圖寫眞の右圖は小椅子として使つた時である。左圖は三段の踏臺とした時で、座板を半分から折りたたんだものである。

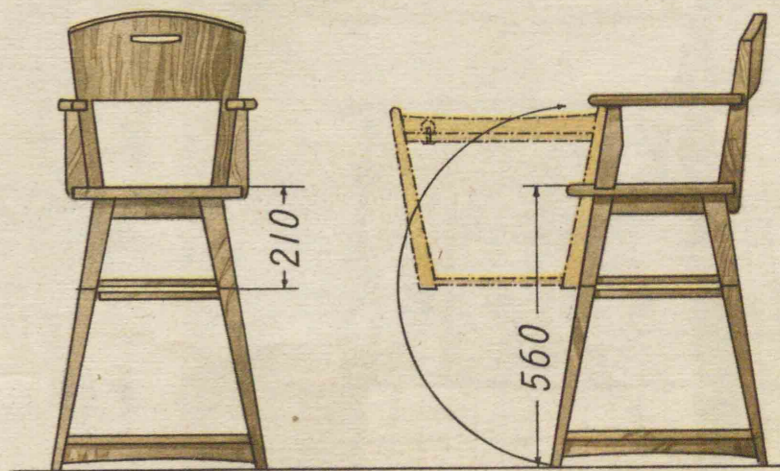

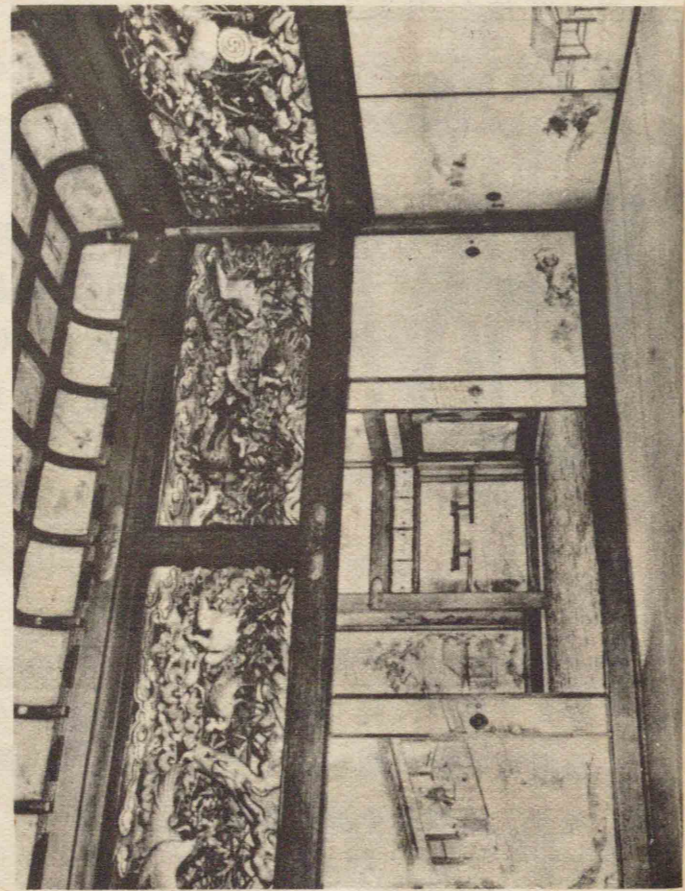
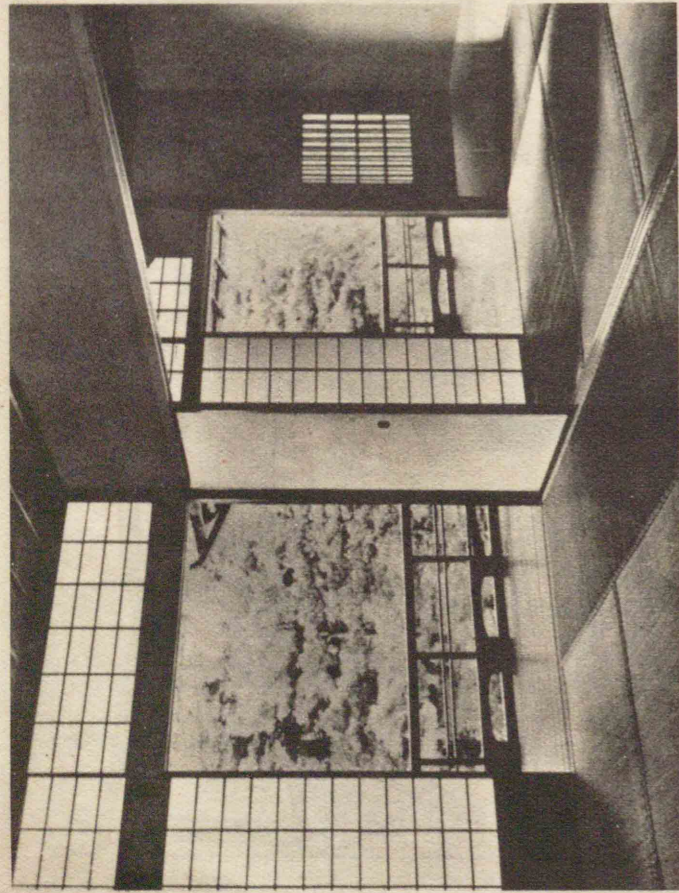

障子・欄間

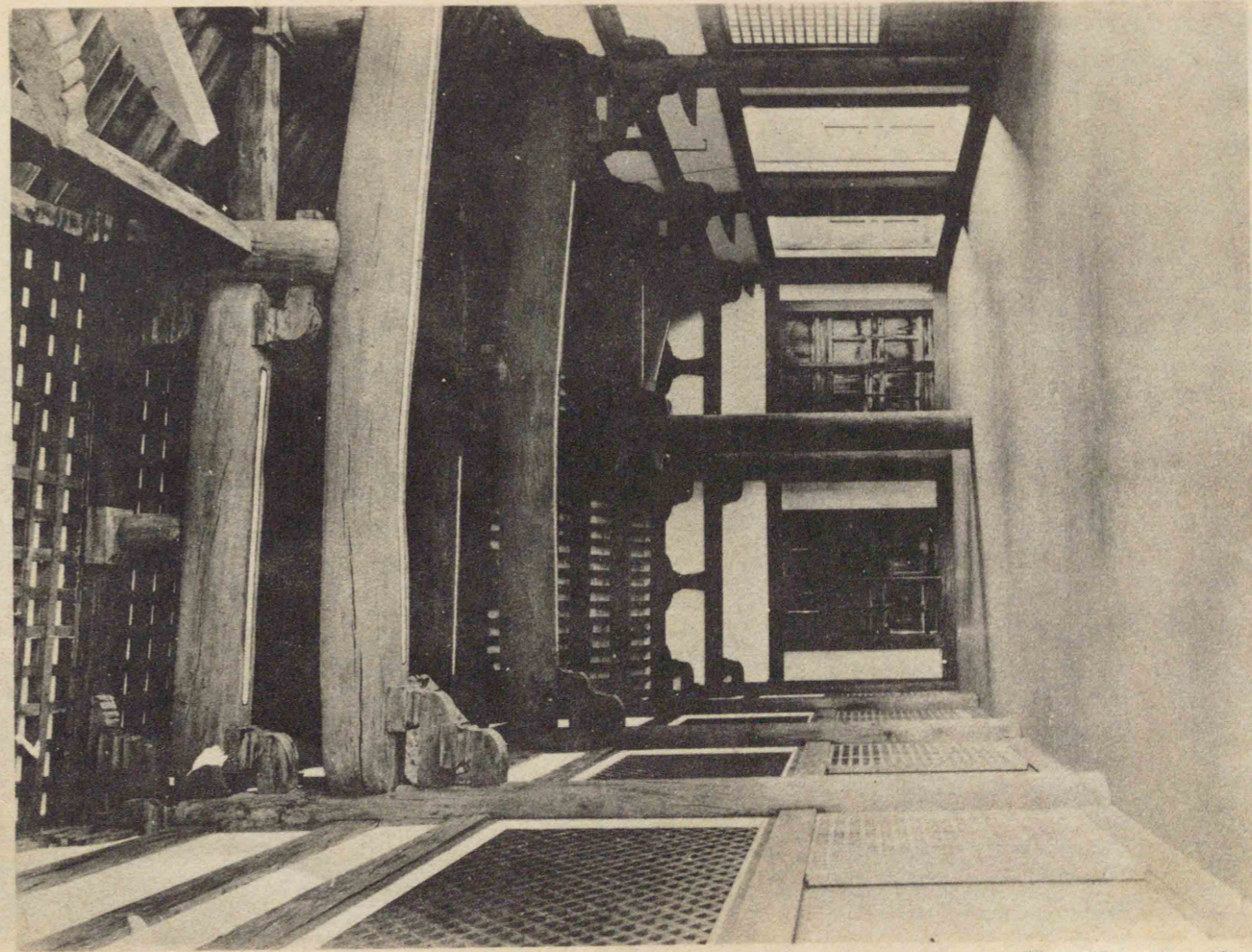

15 鑑賞 建築(三)

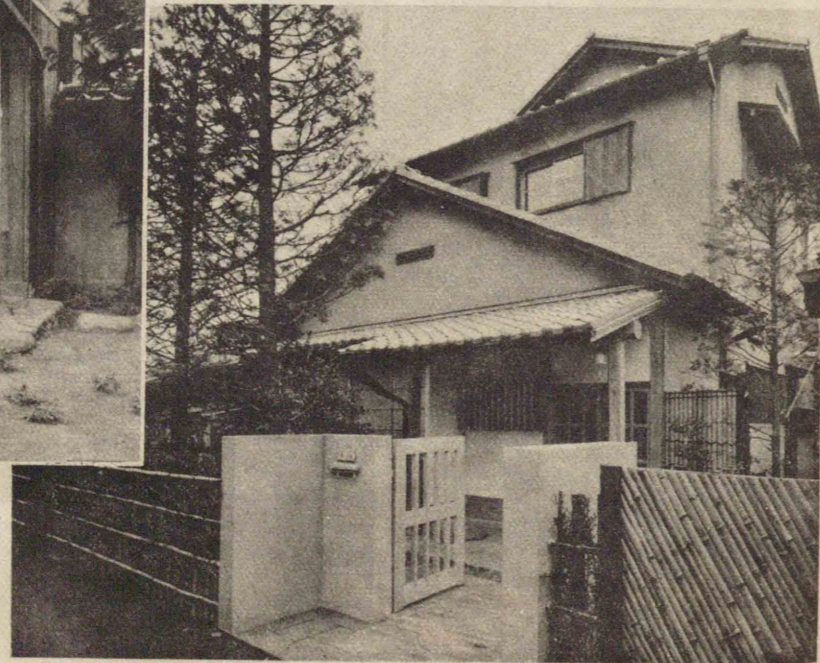
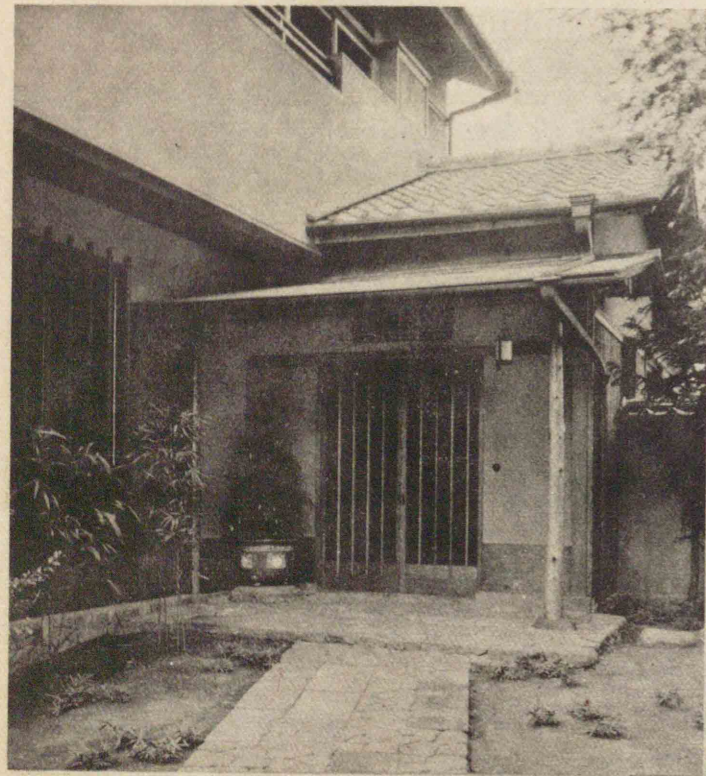

玄関

15 鑑賞 建築(四)

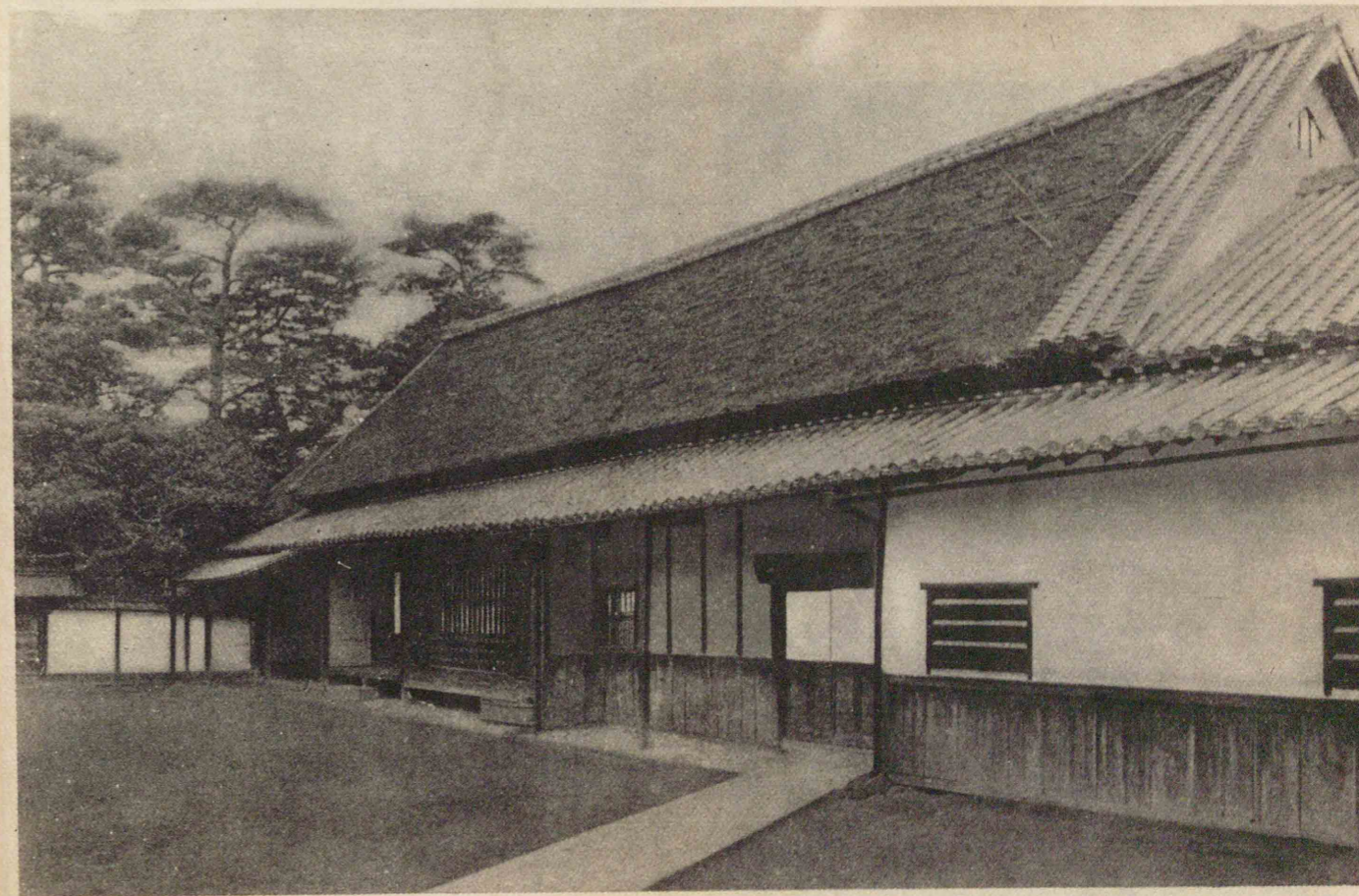

屋根・壁

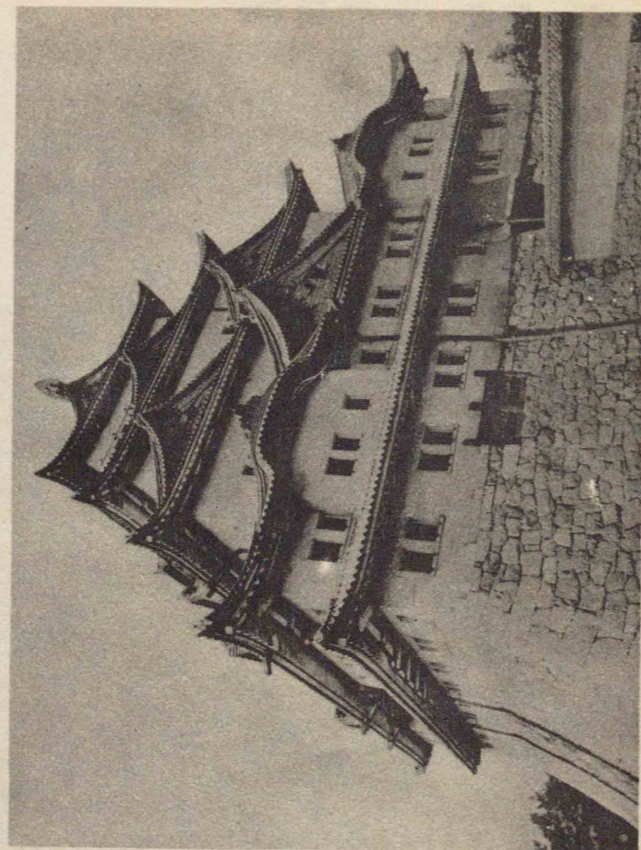
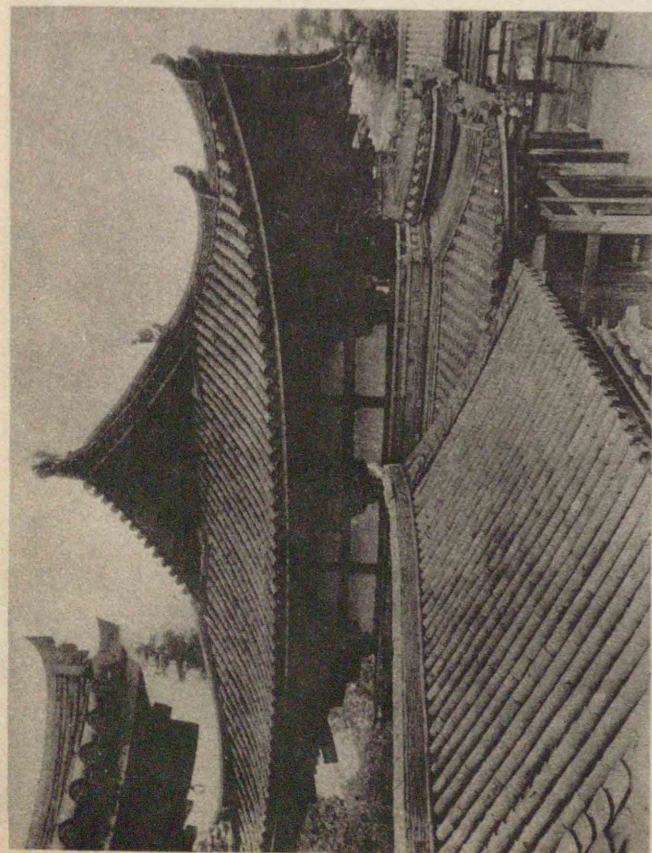

屋根

圖畫 2 (中等學校男子用)

昭和18年12月27日印刷  
昭和18年12月31日發行

定價 52 錢

著作權所有

著作兼發行者

東京都神田區岩本町三番地  
中等學校教科書株式會社  
代表者 山本慶治

印刷者

東京都牛込區市谷加賀町一丁目十二番地  
大日本印刷株式會社  
(東京一) 代表者 佐久間長吉郎

配給元

東京都神田區淡路町二丁目九番地  
日本出版配給株式會社

發行所

東京都神田區岩本町三番地  
中等學校教科書株式會社  
日本出版會會員番號 117522

(略名) 中教圖書男2

繪畫寫眞の複寫複製は海軍省檢閱濟(第1002號)

