



教科書文庫  
4  
710  
33-1944  
2000035891

高等科圖畫一

女子用

文部省

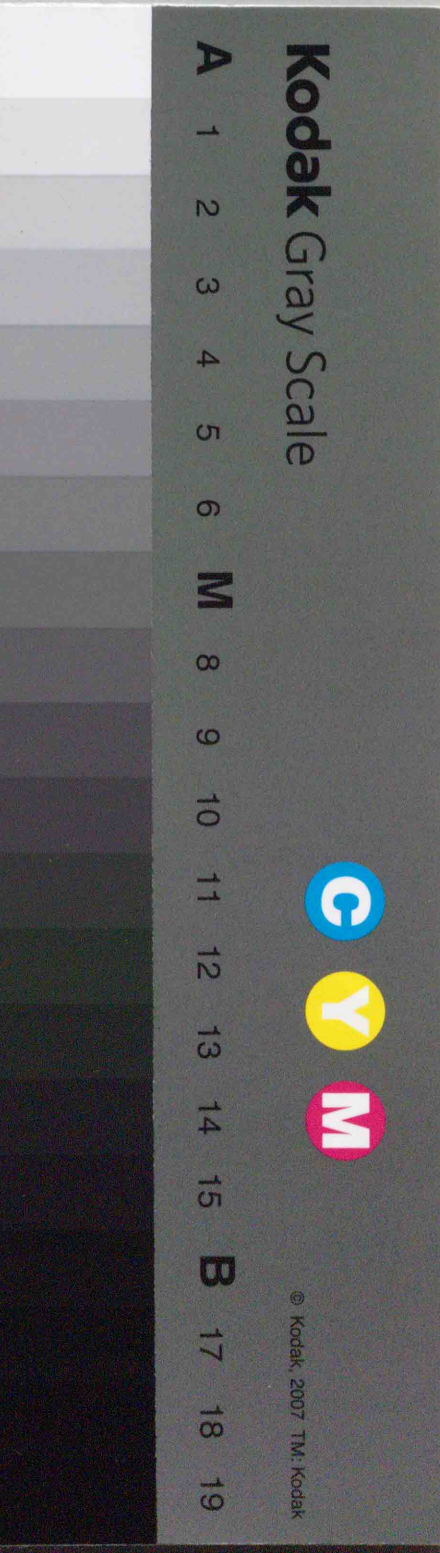
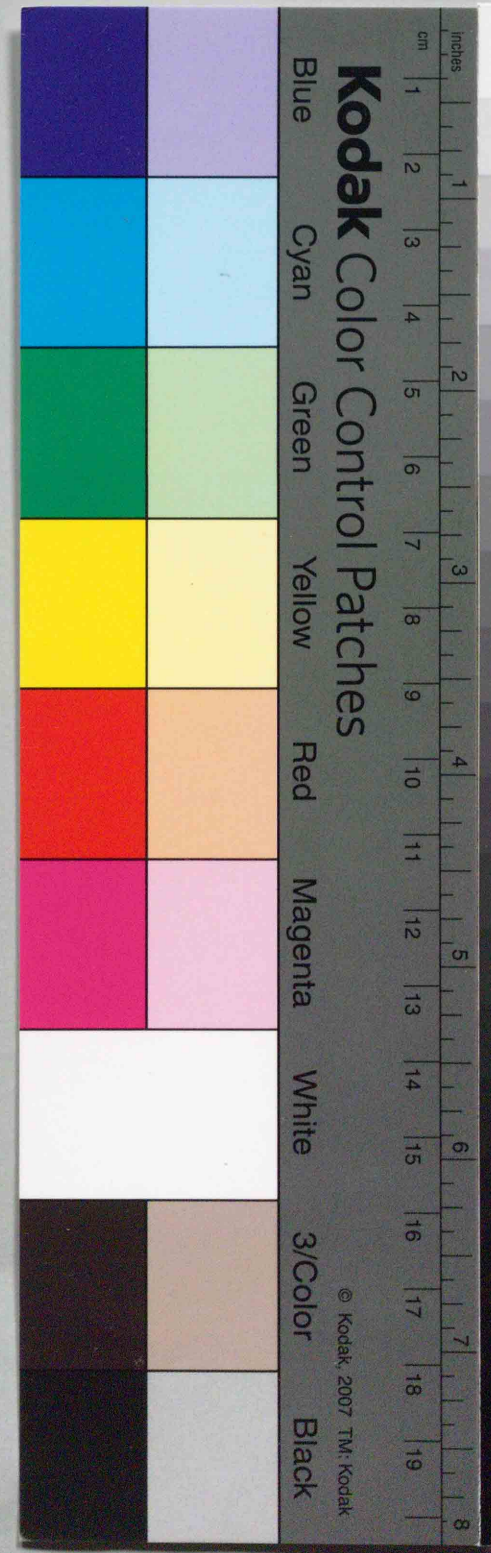
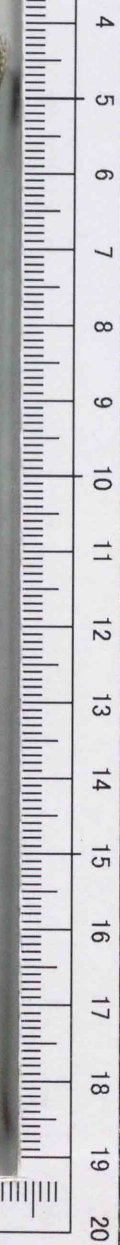
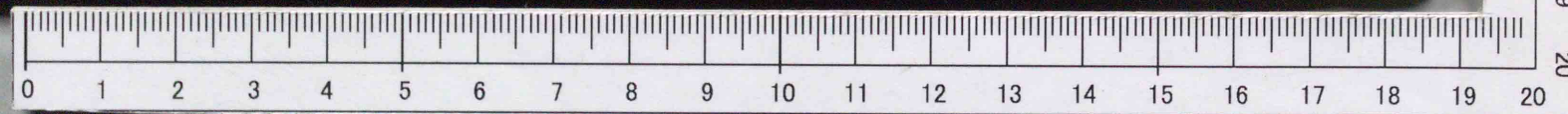

40676

教科書文庫

4
710
33-1944
20000 35891



© Kodak, 2007 TM: Kodak

© Kodak, 2007 TM: Kodak

395.9  
Mo 4p

資料室

教科書文庫  
4  
710  
33-1944  
2000035891

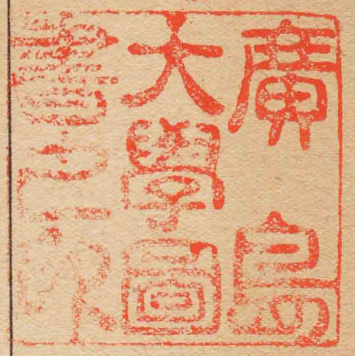

文  
部  
省



高等科圖畫一

女子用

広島大学図書  
2000035891  

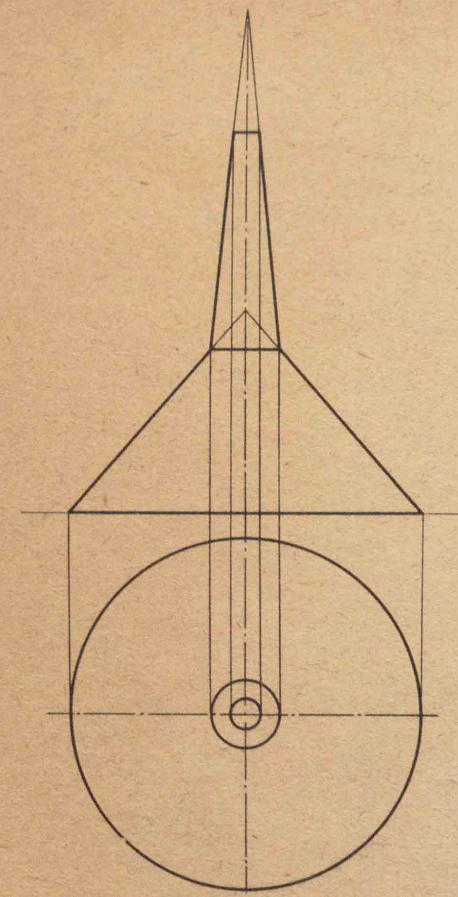
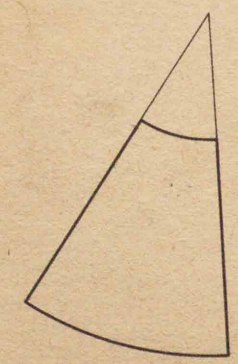
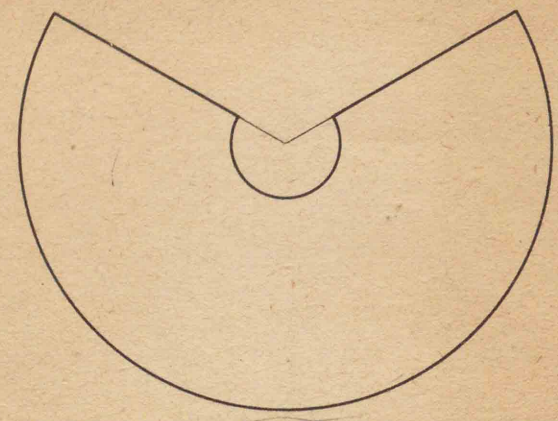
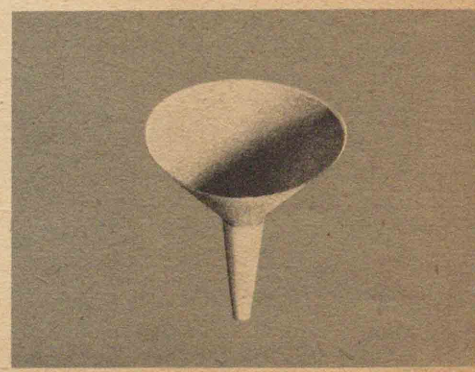

目録

- 一、投影圖と展開圖
- 二、形
- 三、速寫
- 四、毛筆畫
- 五、植物
- 六、形の構成
- 七、色
- 八、手藝圖案
- 九、室内裝置
- 十、ミシン
- 十一、讀圖
- 十二、器具の創案

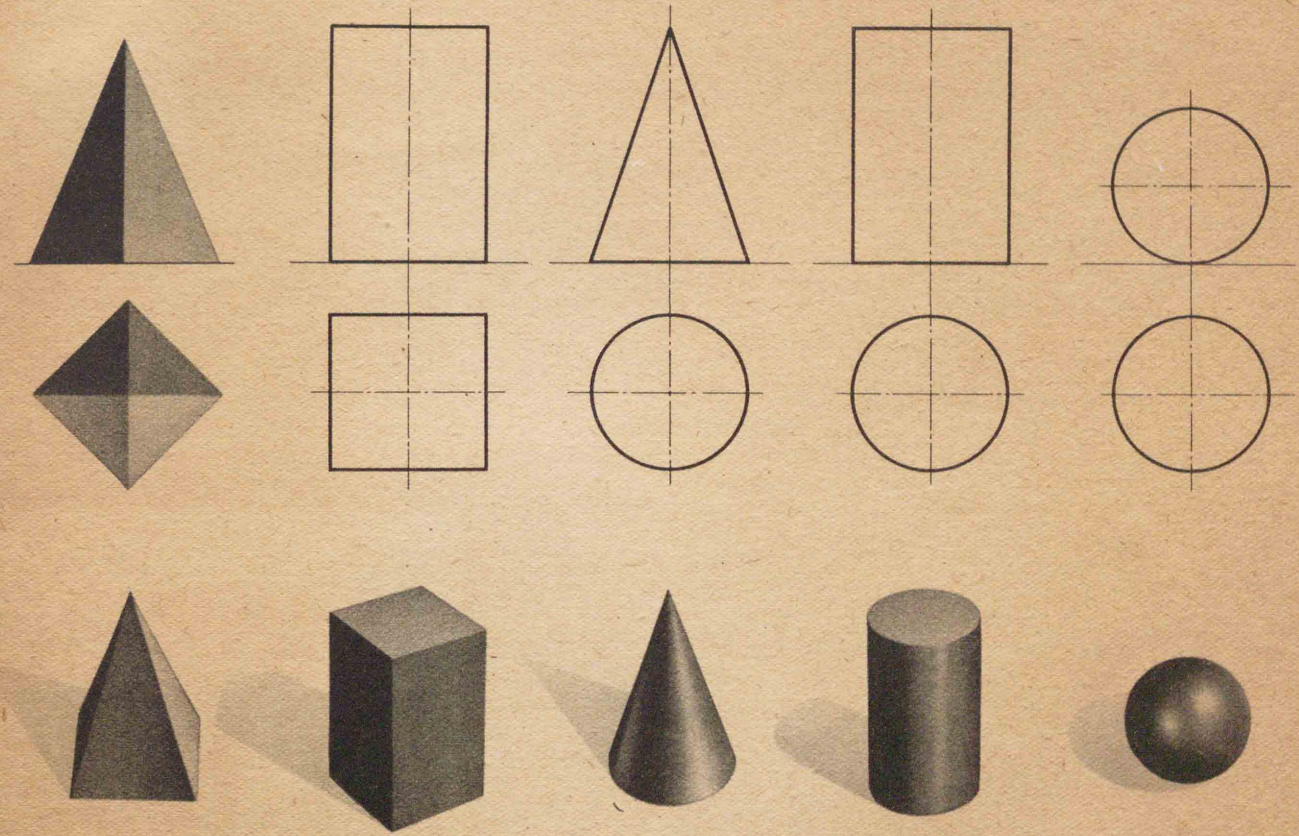
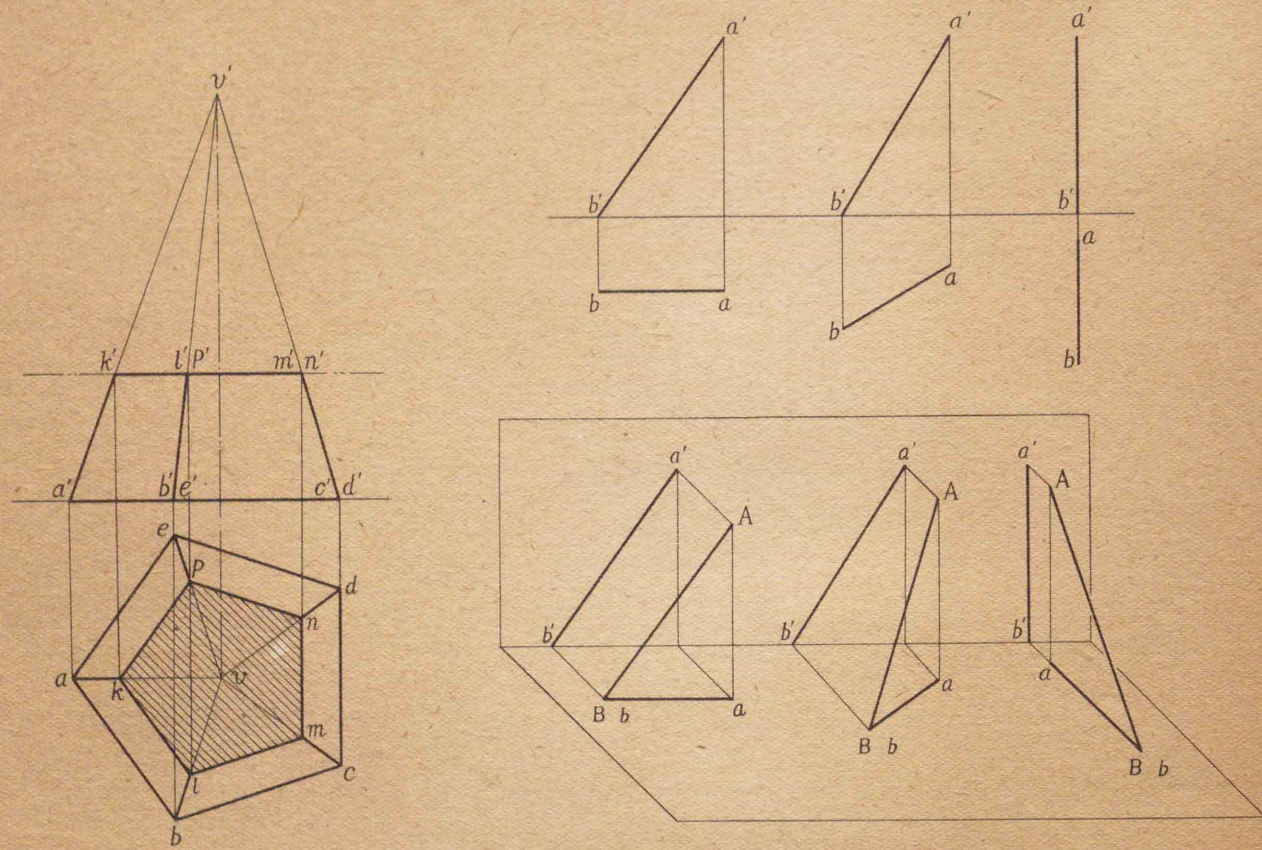

一、投影圖と展開圖 その一

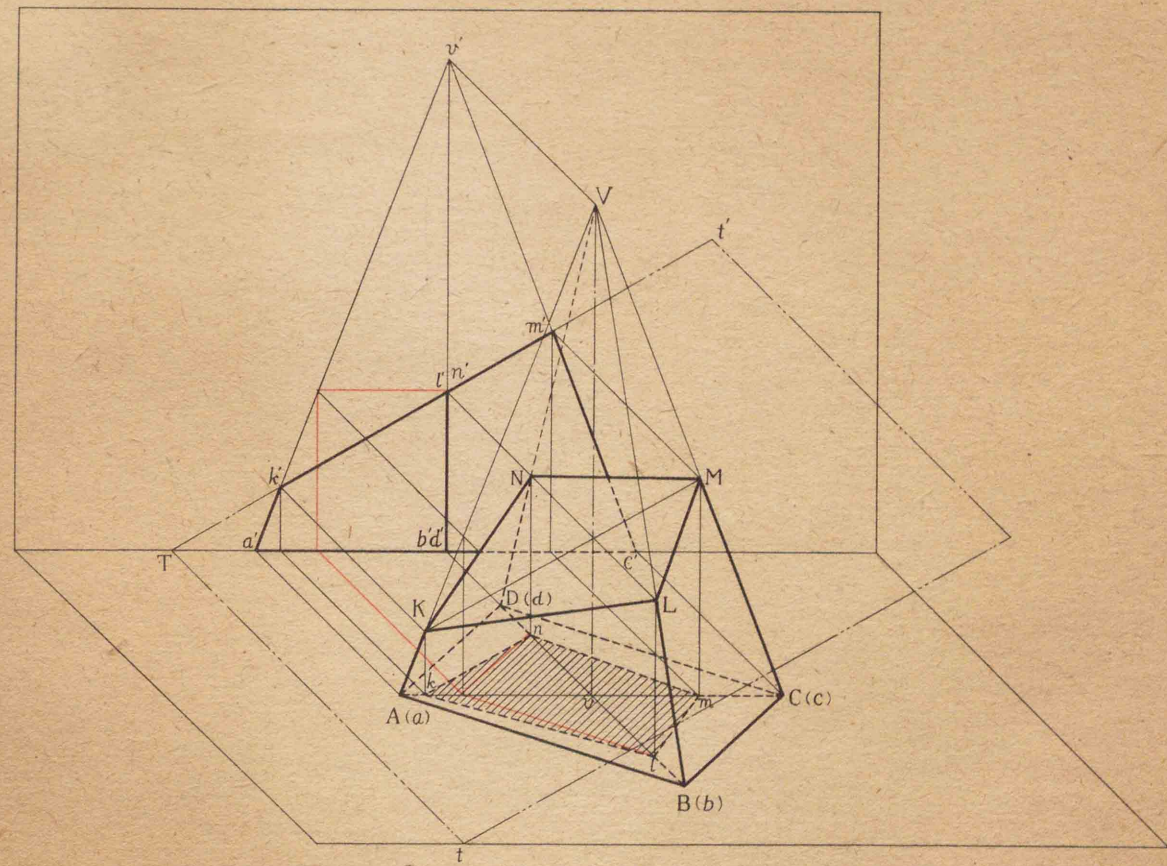
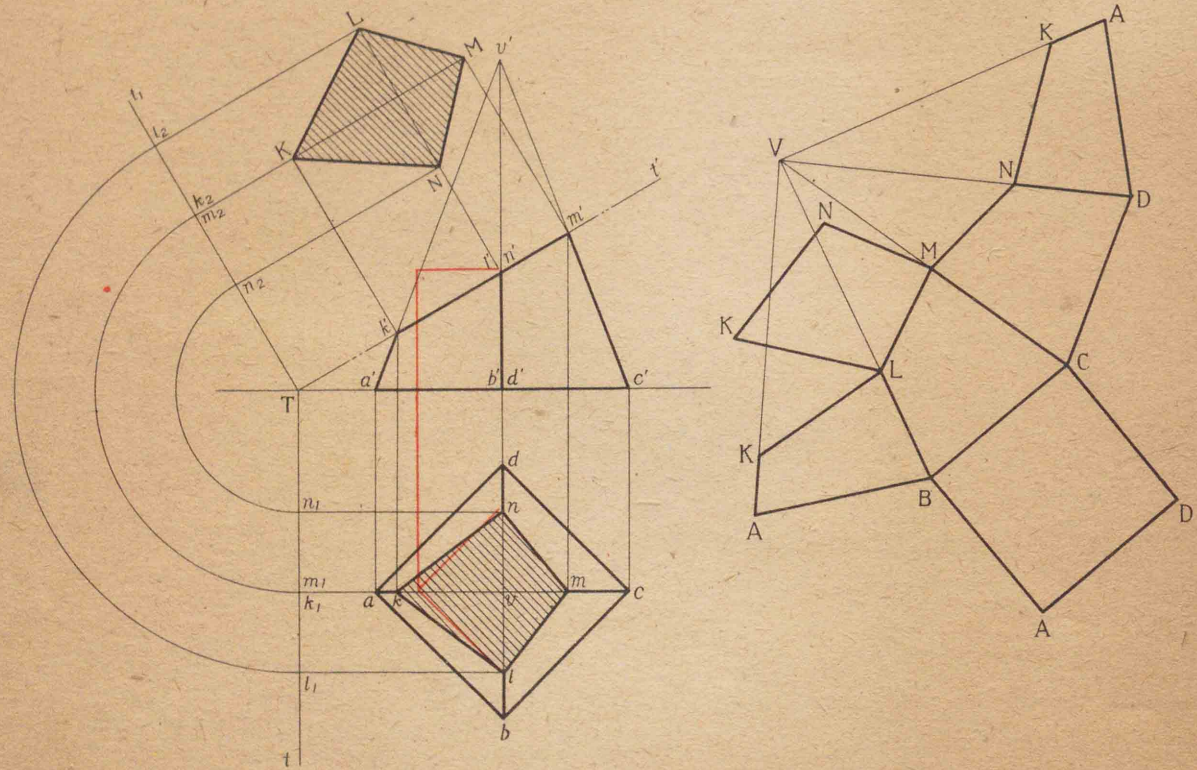



形  
その二

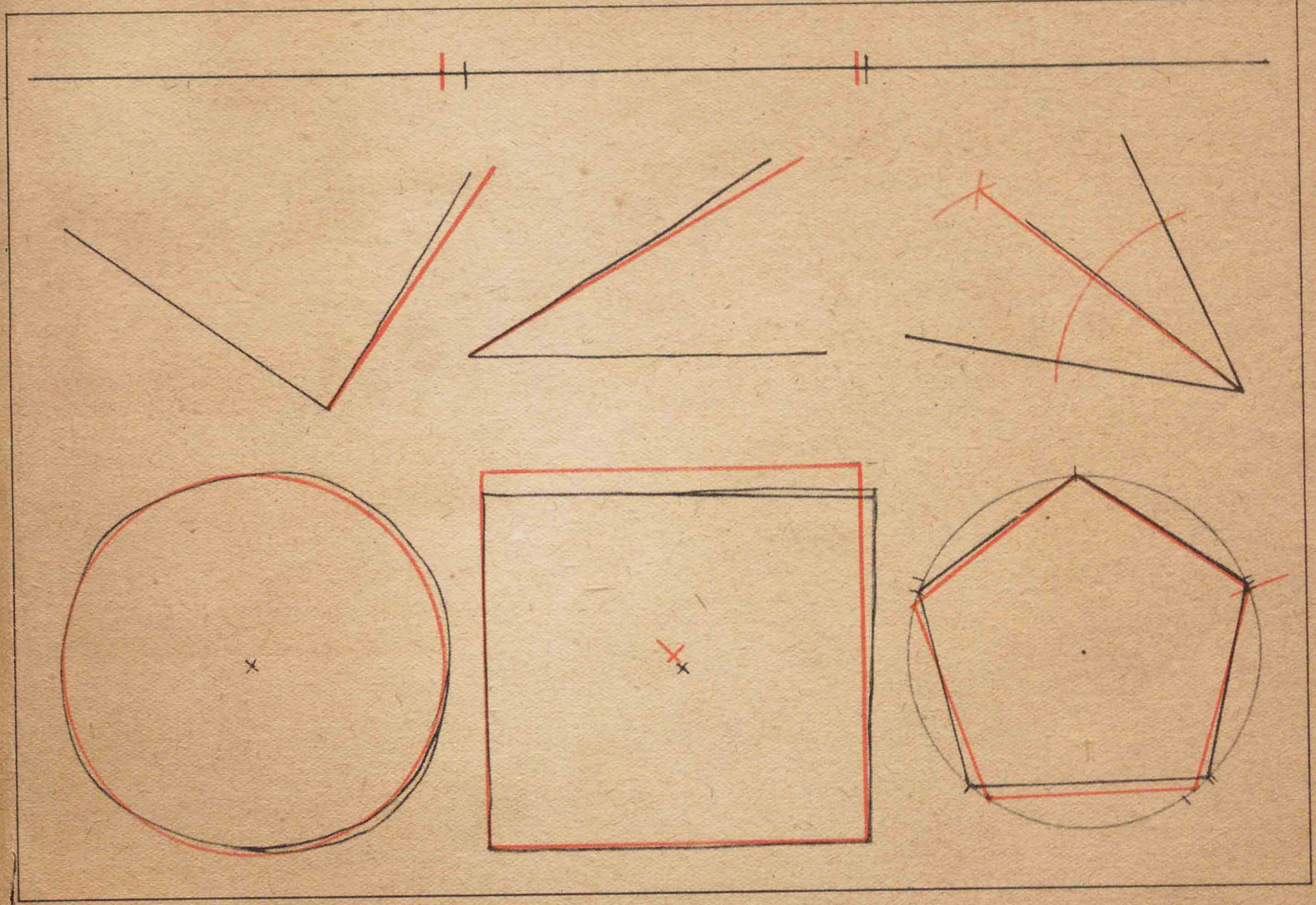
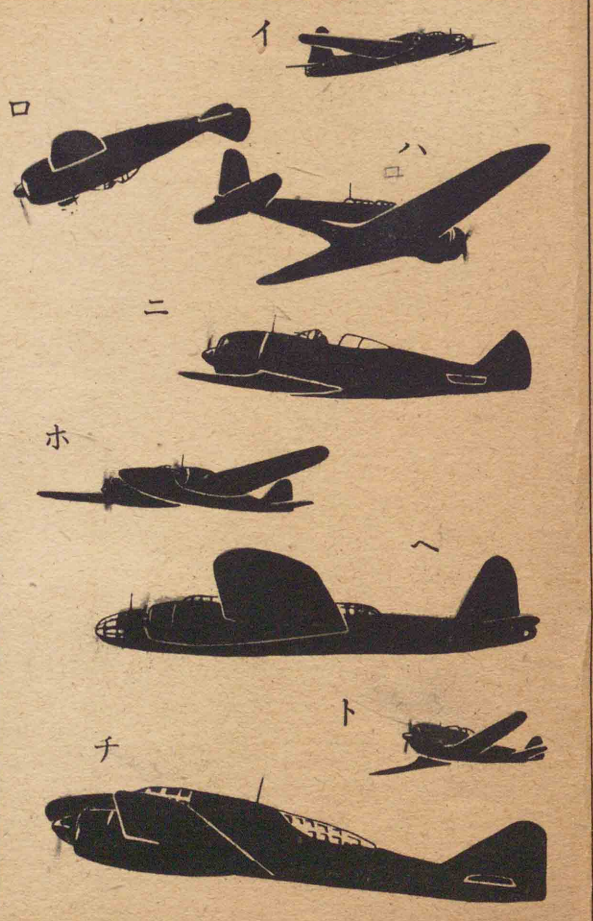
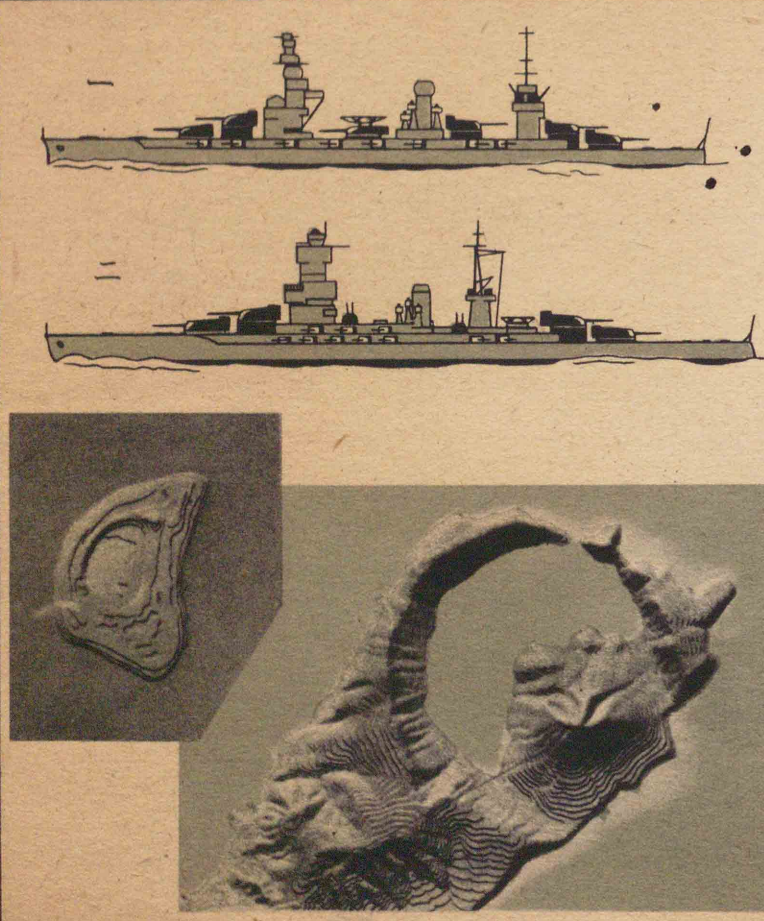

二形  
その一

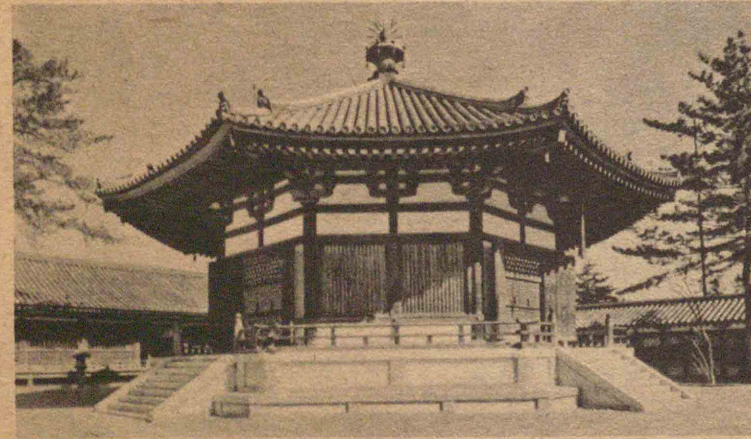

形  
その四

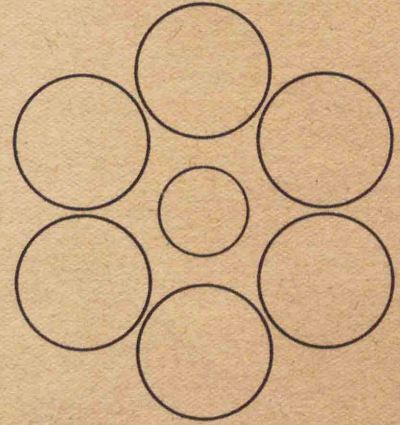
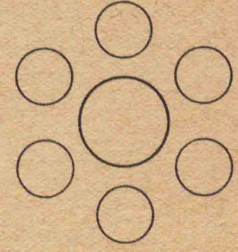
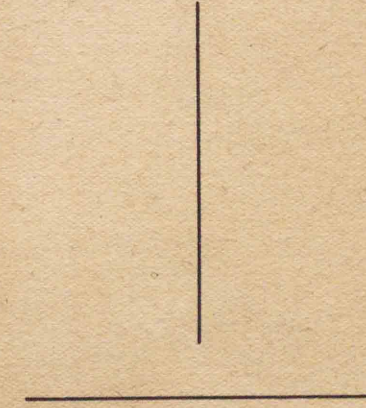
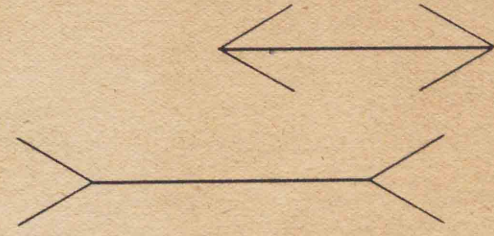
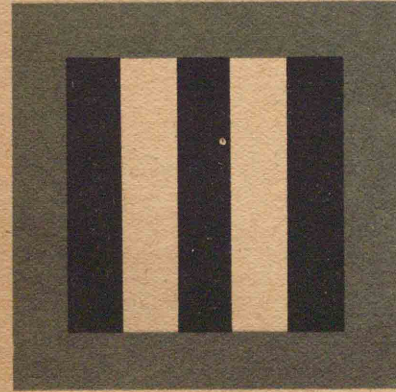
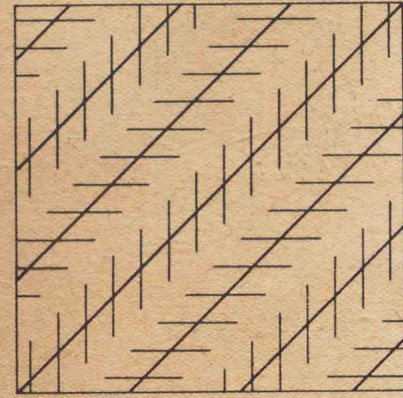
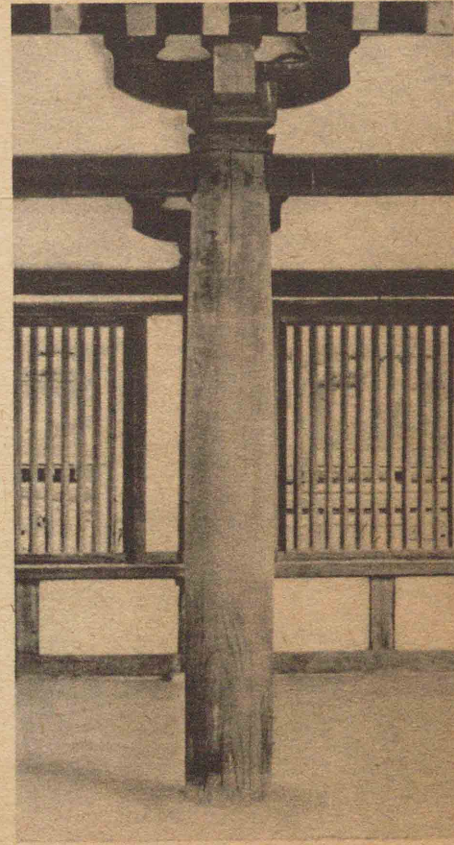

形  
その三

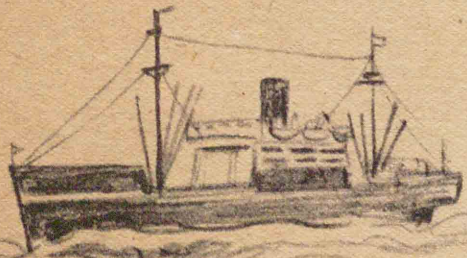
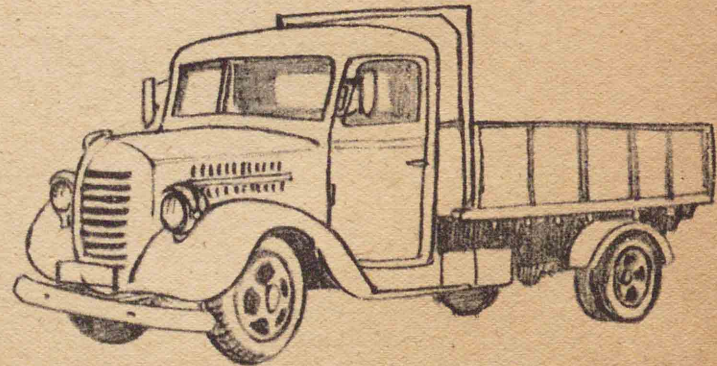
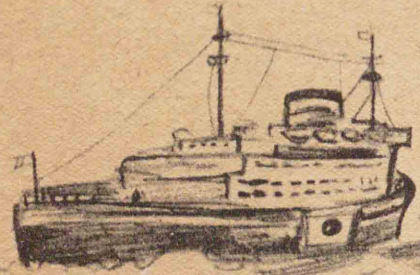
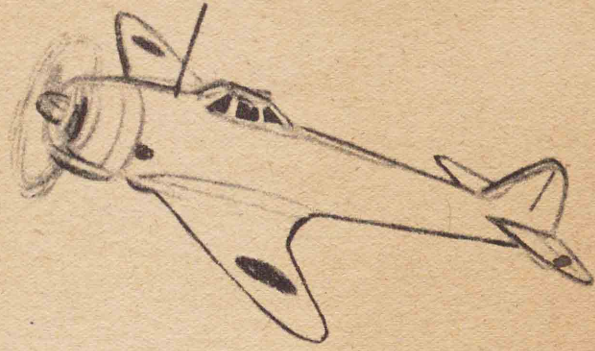

速  
寫  
その  
四



三、速  
寫  
その  
一





植  
物  
その二



五、植  
物  
その一



形の構成 その二

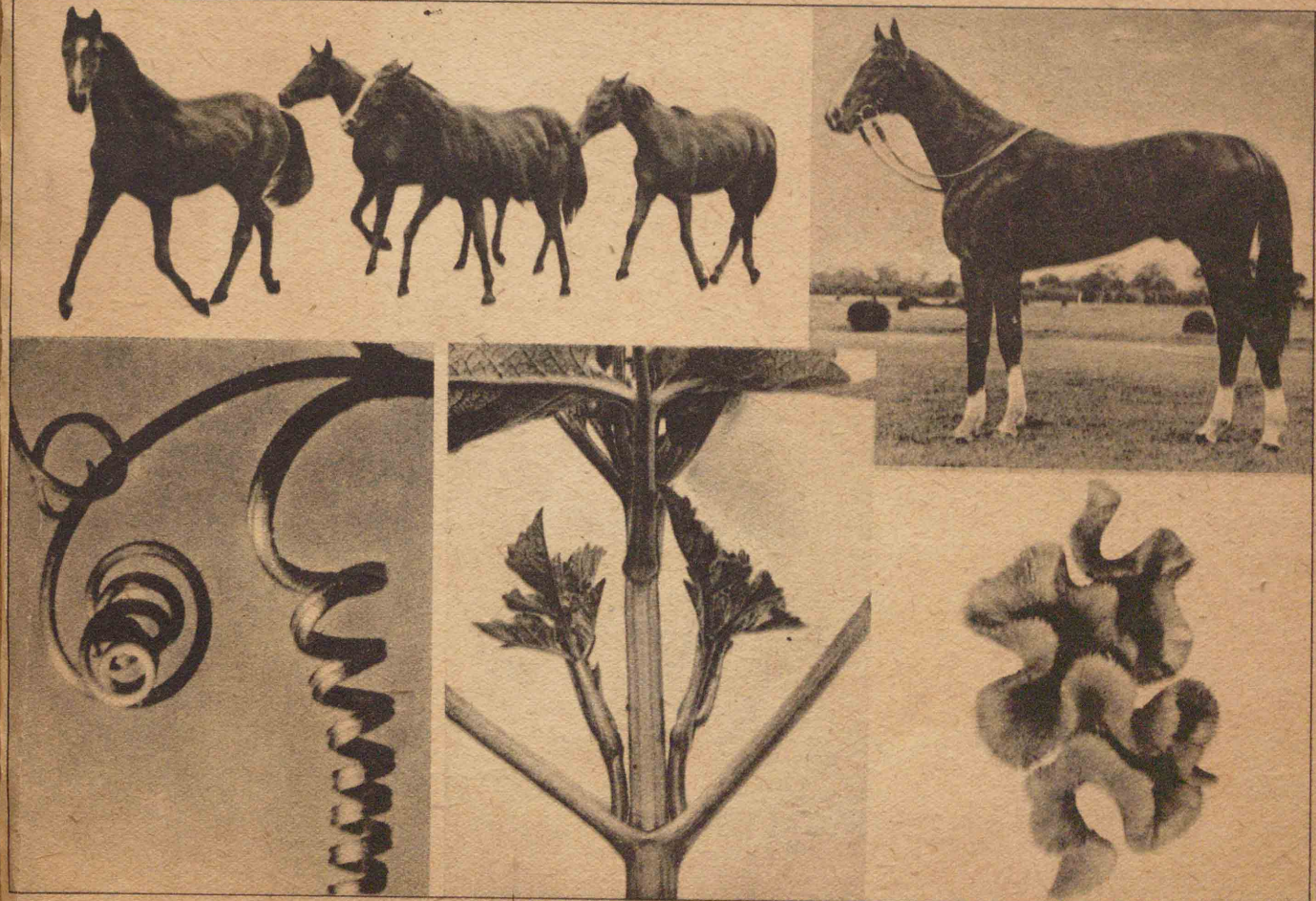

六、形の構成 その一

形の構成 その四

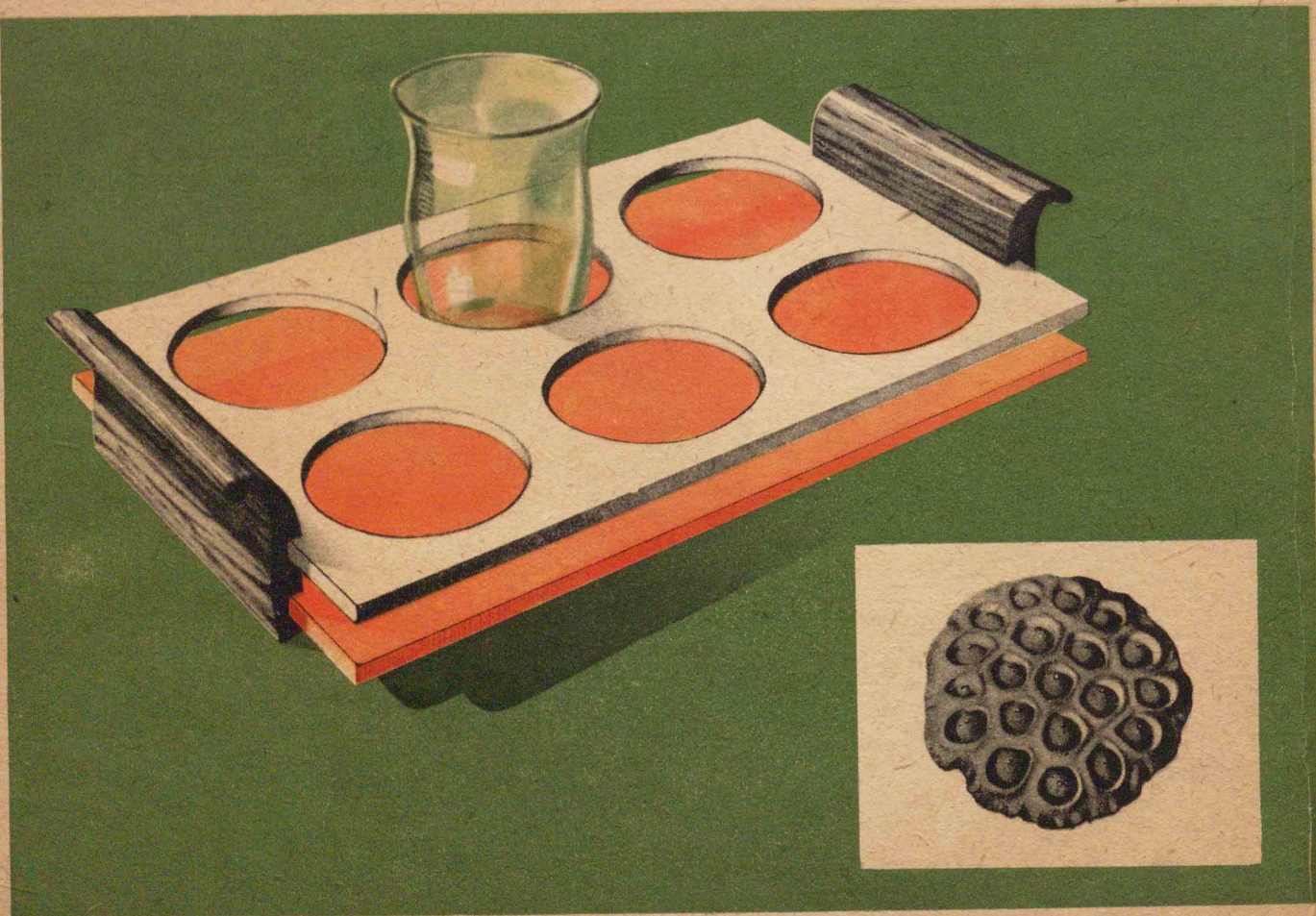

形の構成 その三



形の構成 その六

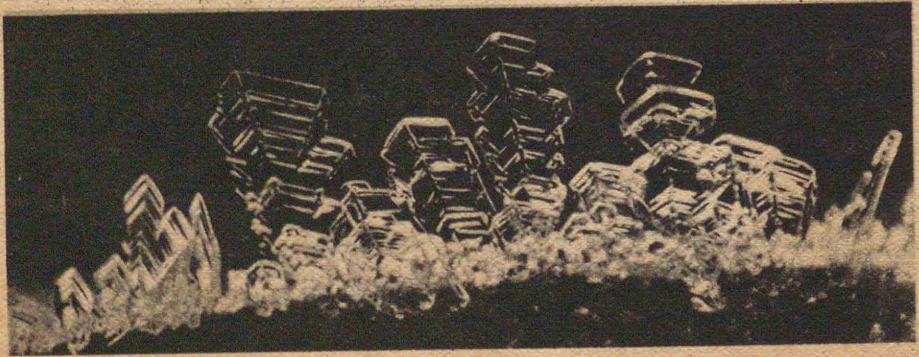
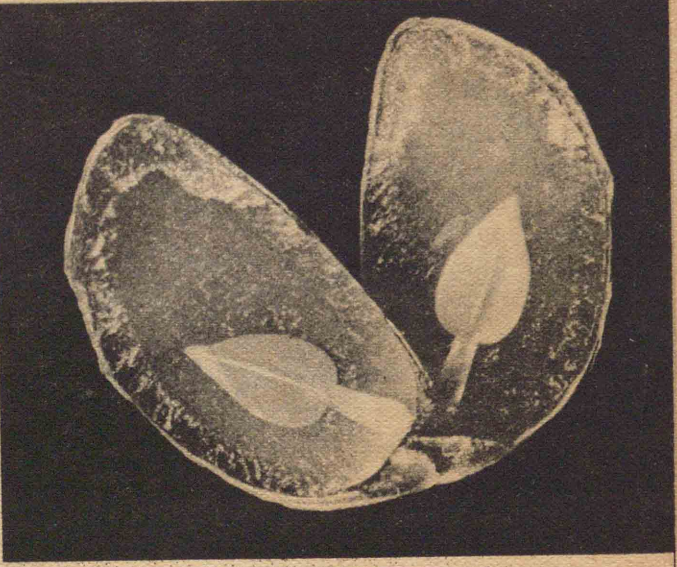
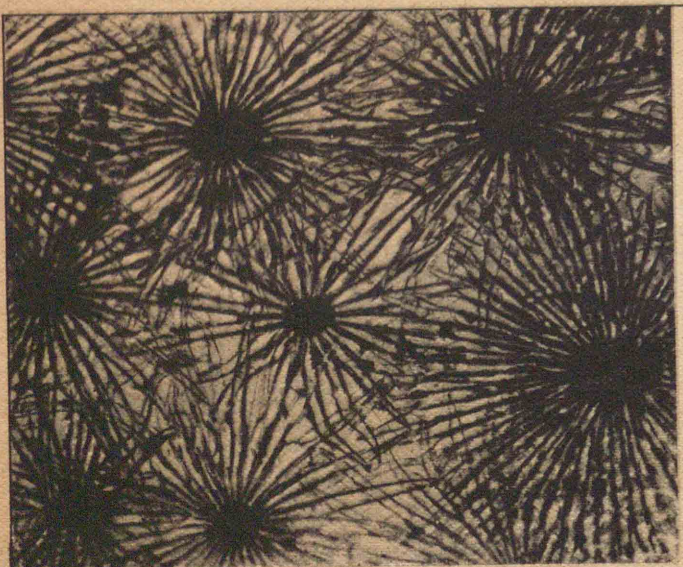

形の構成 その五

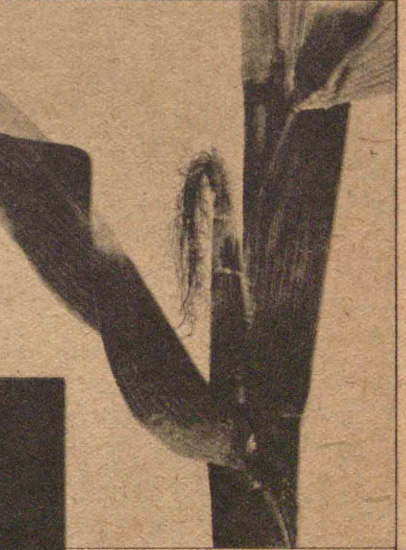
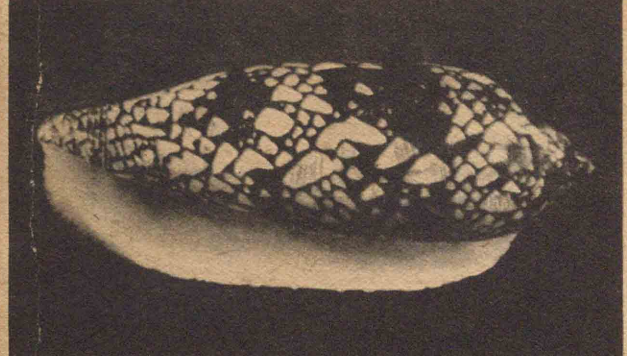

色  
その二

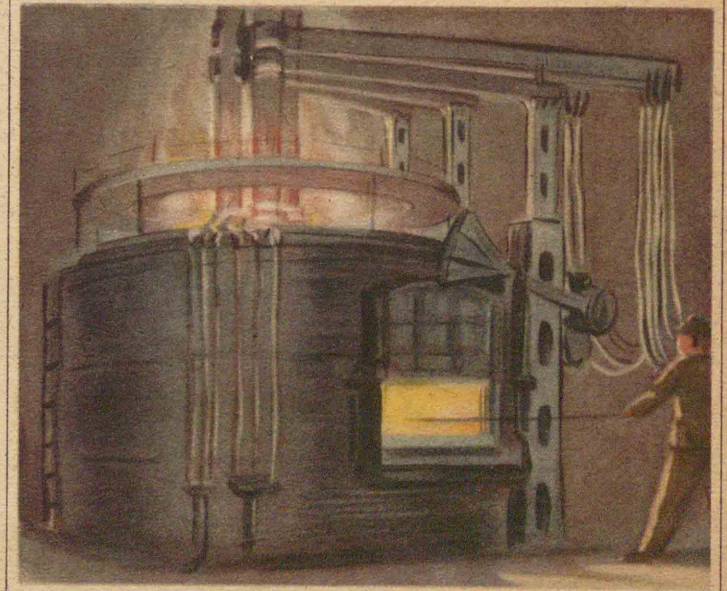
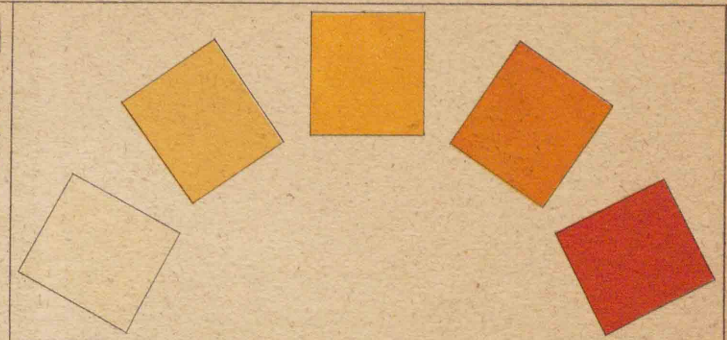
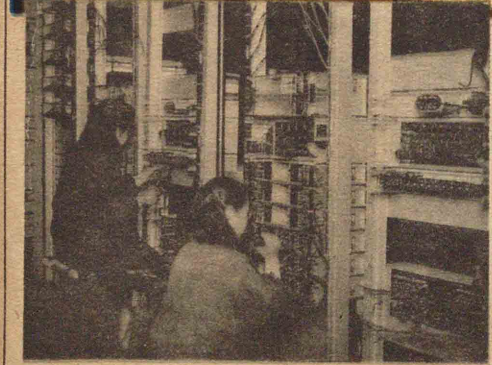
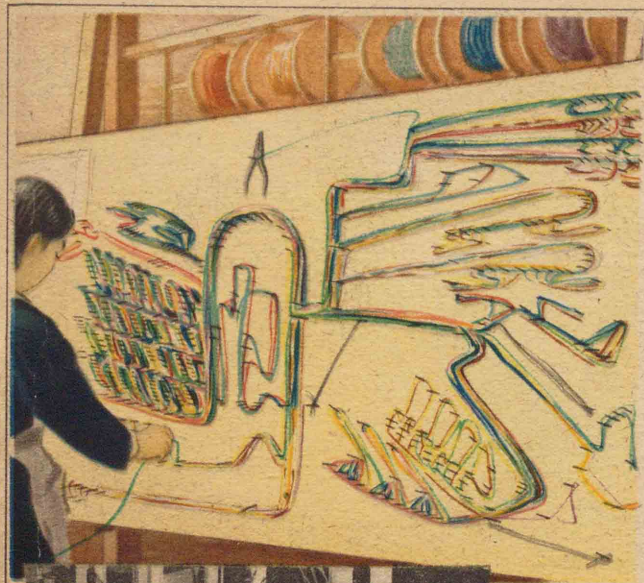
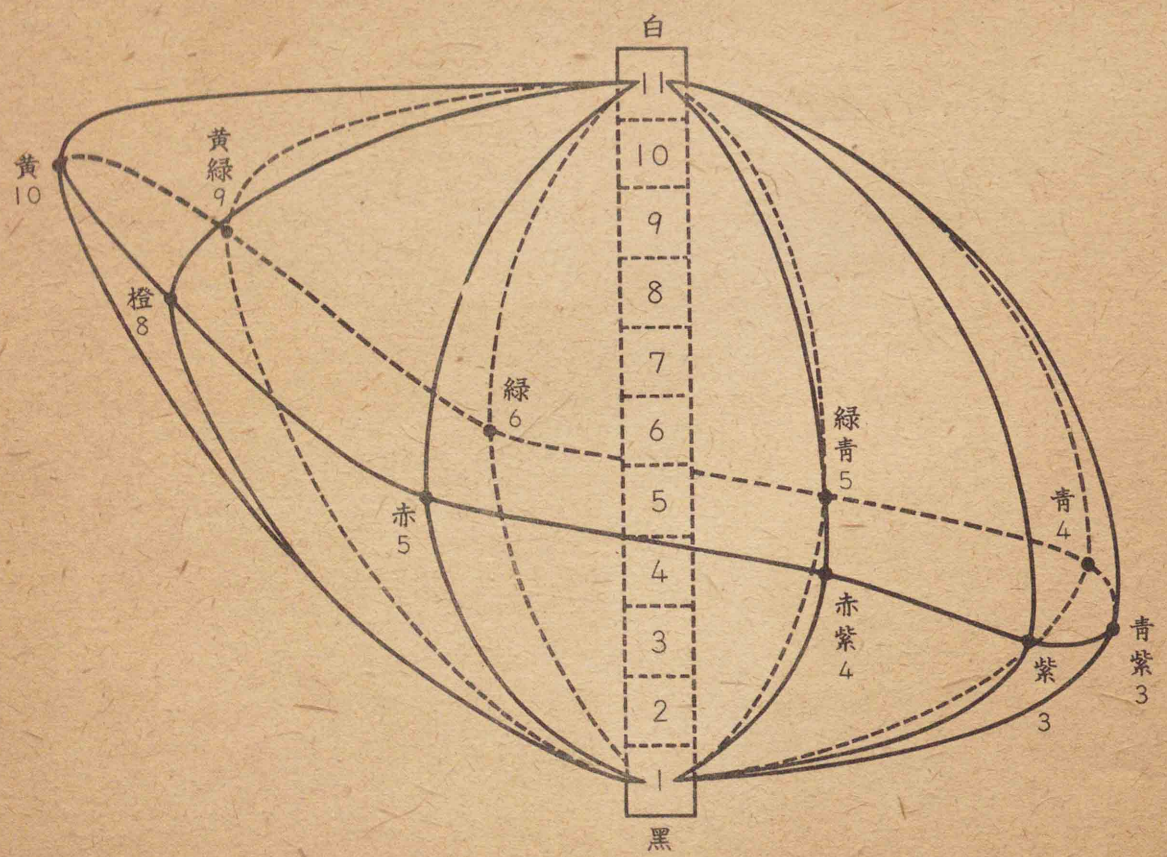

七、色  
その一

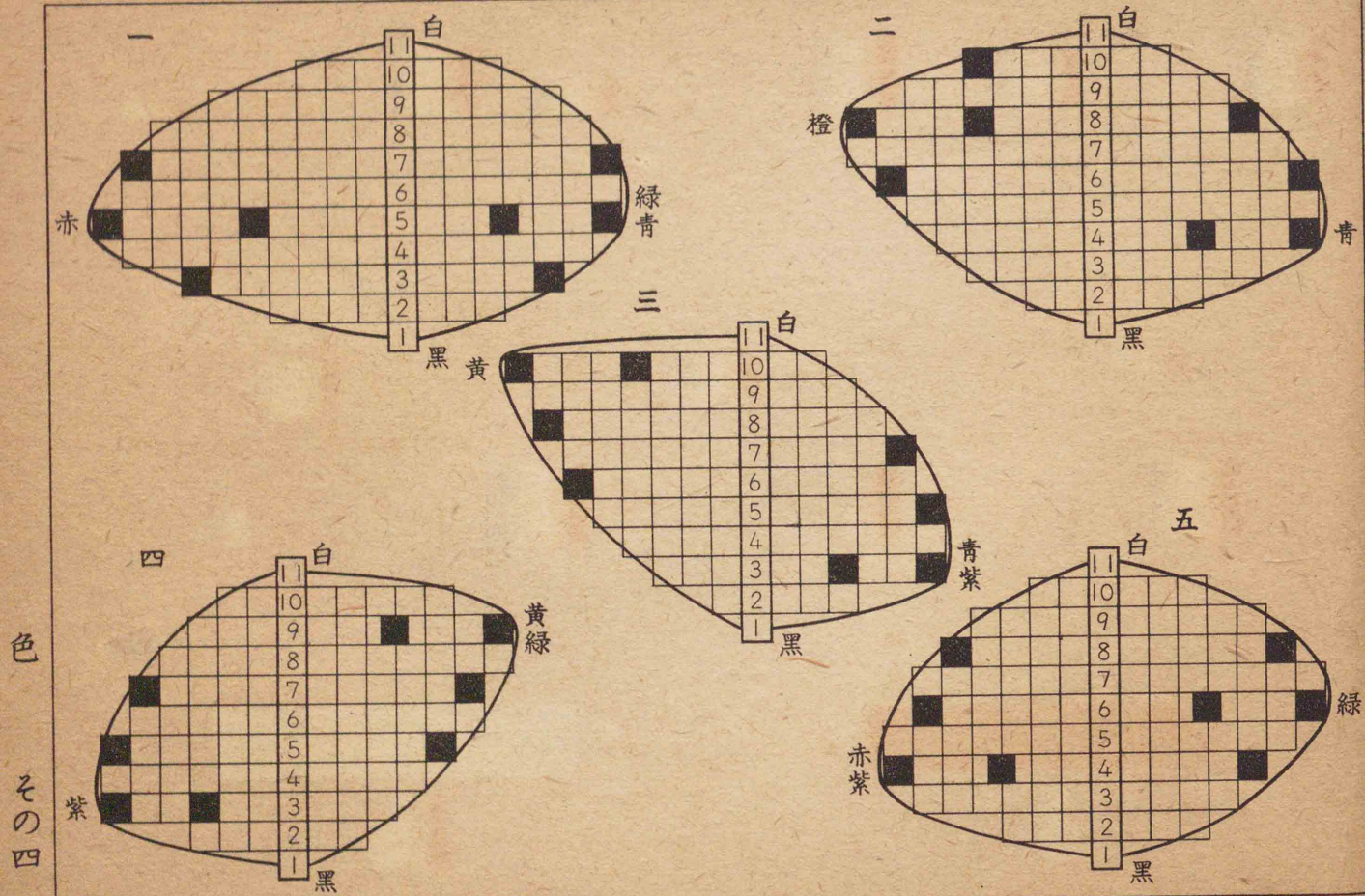

色  
その四

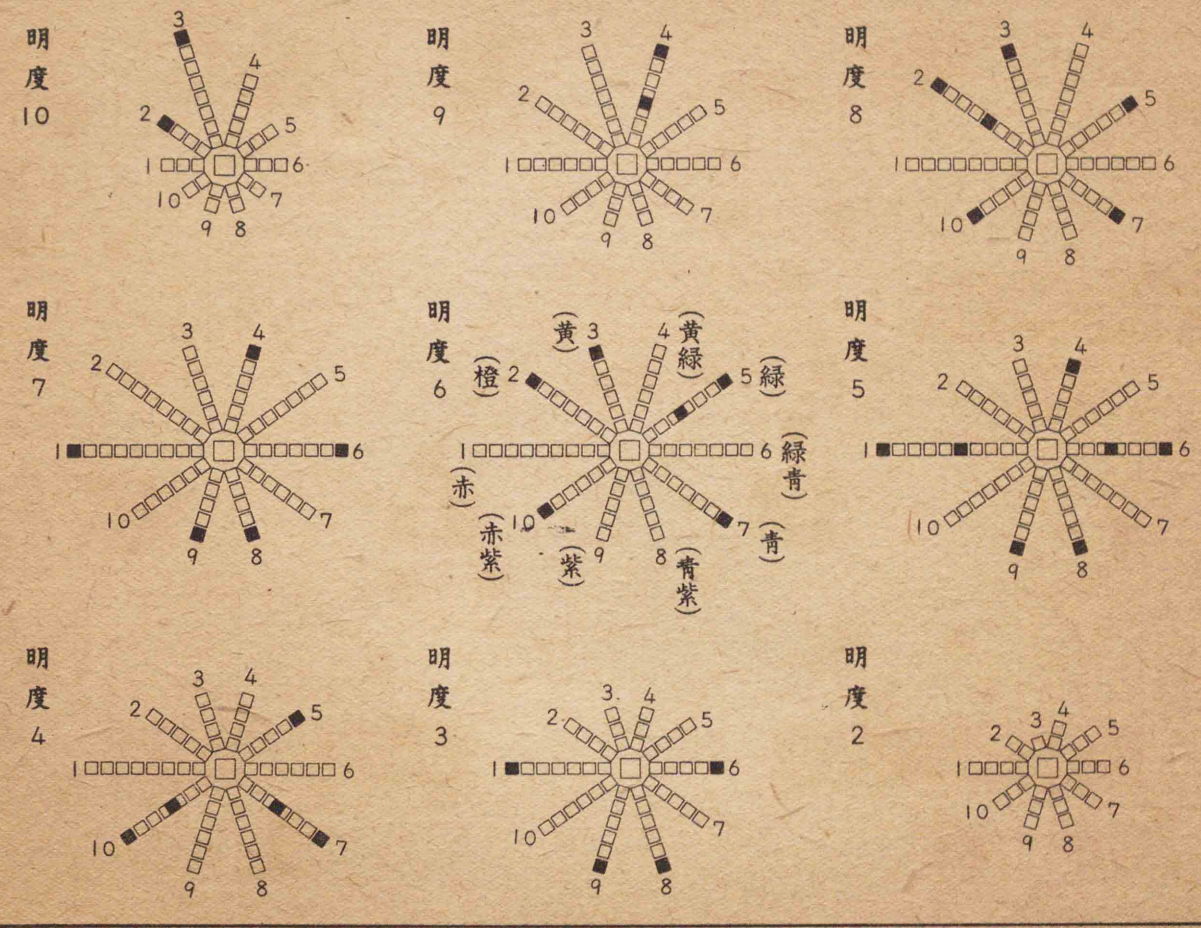

色  
その三

色  
その六

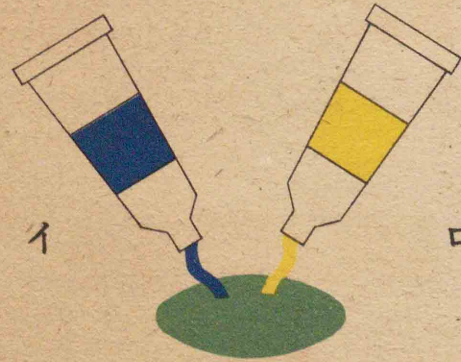
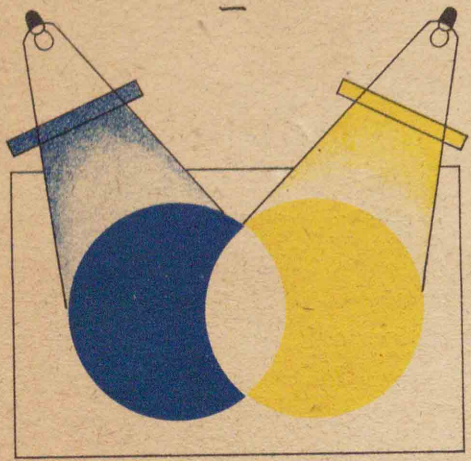

ロ

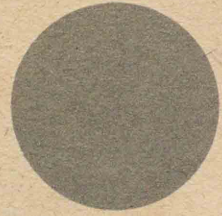
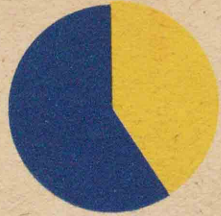
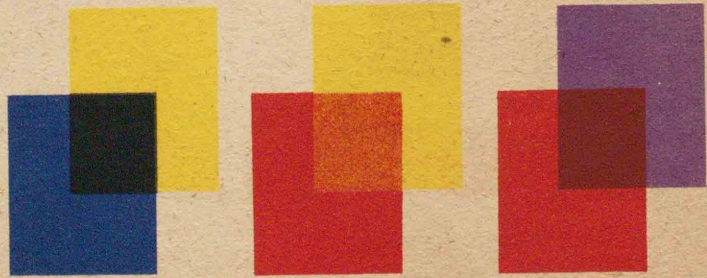

三

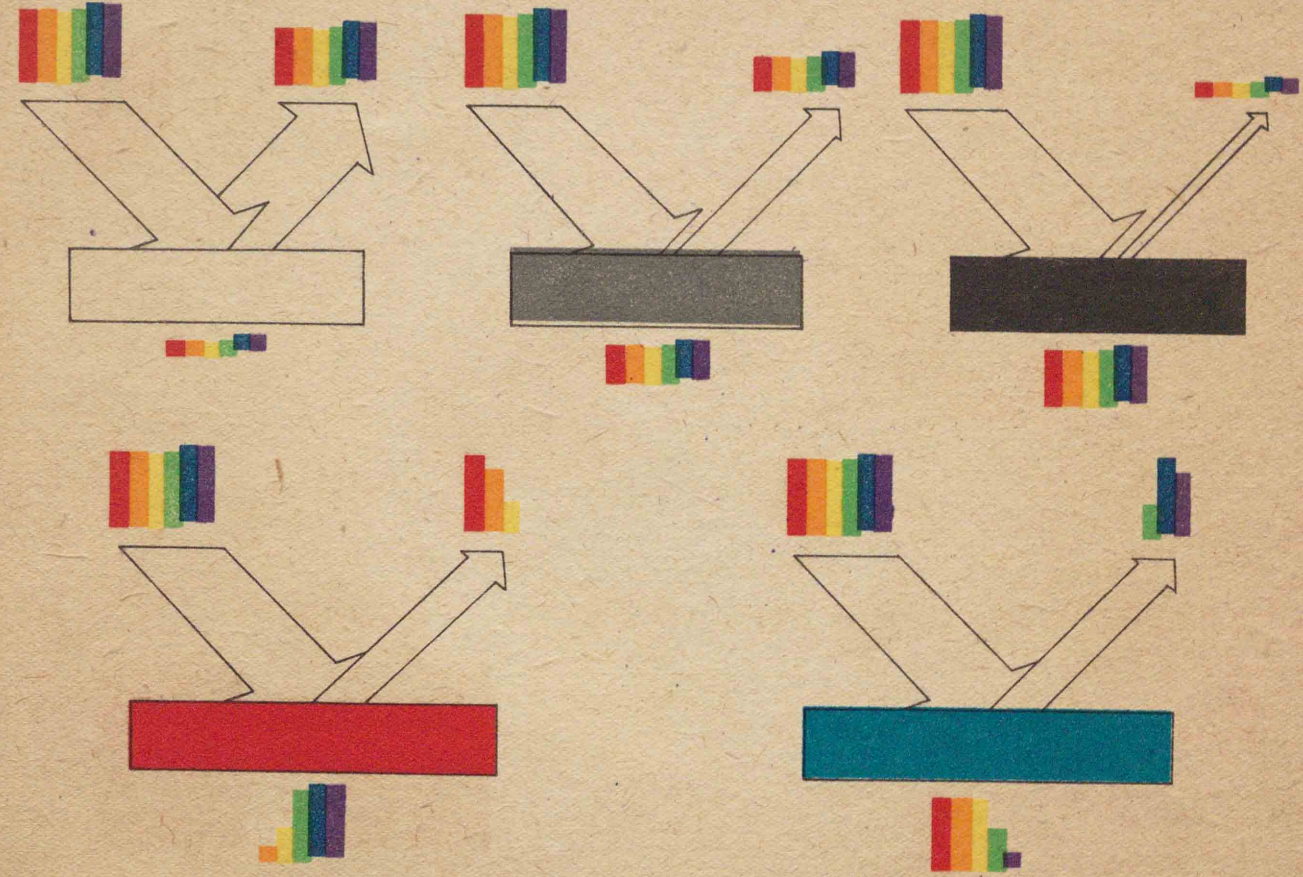
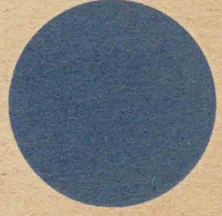
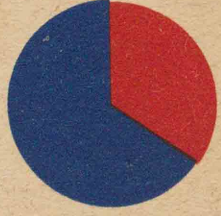

色  
その五





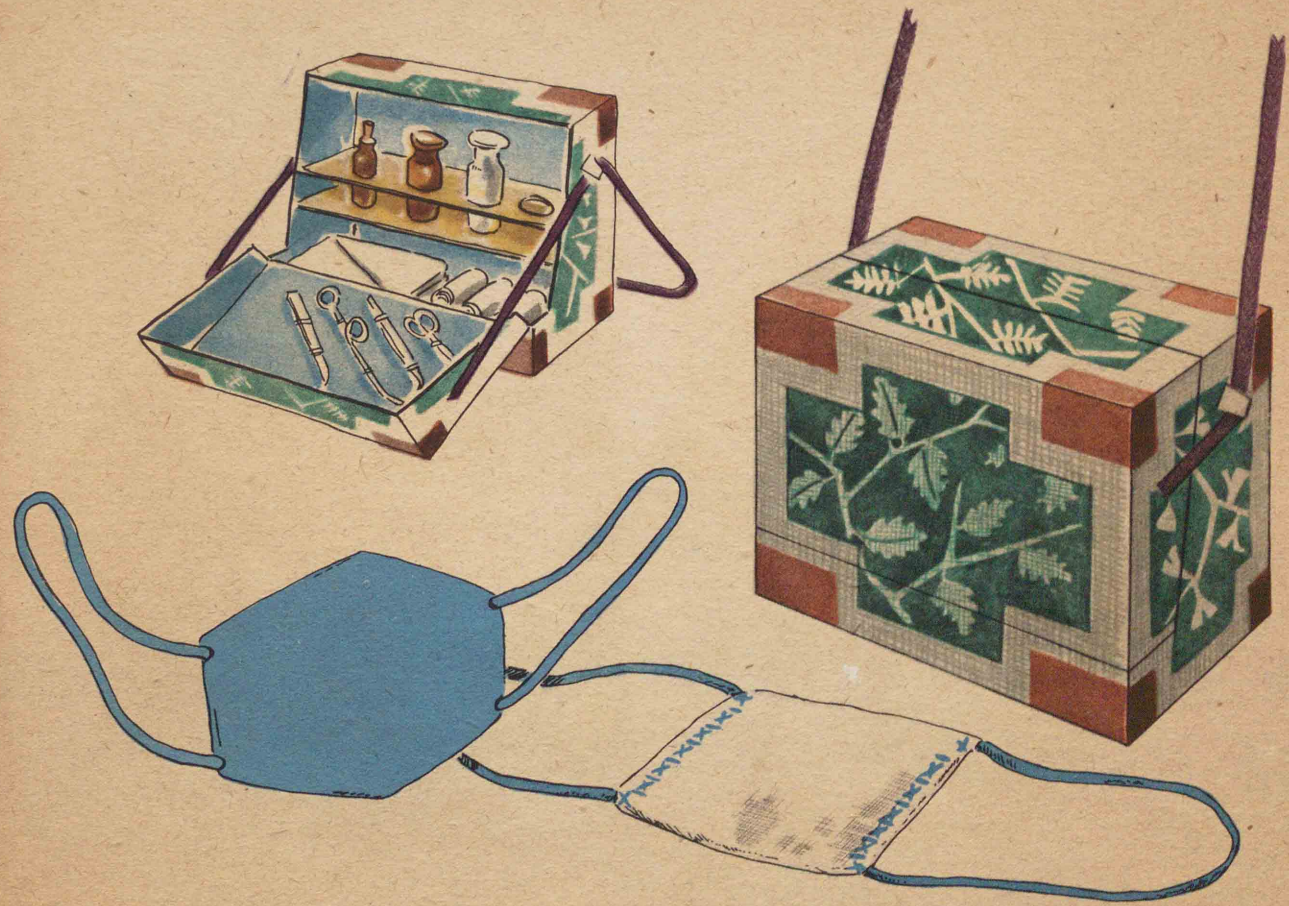

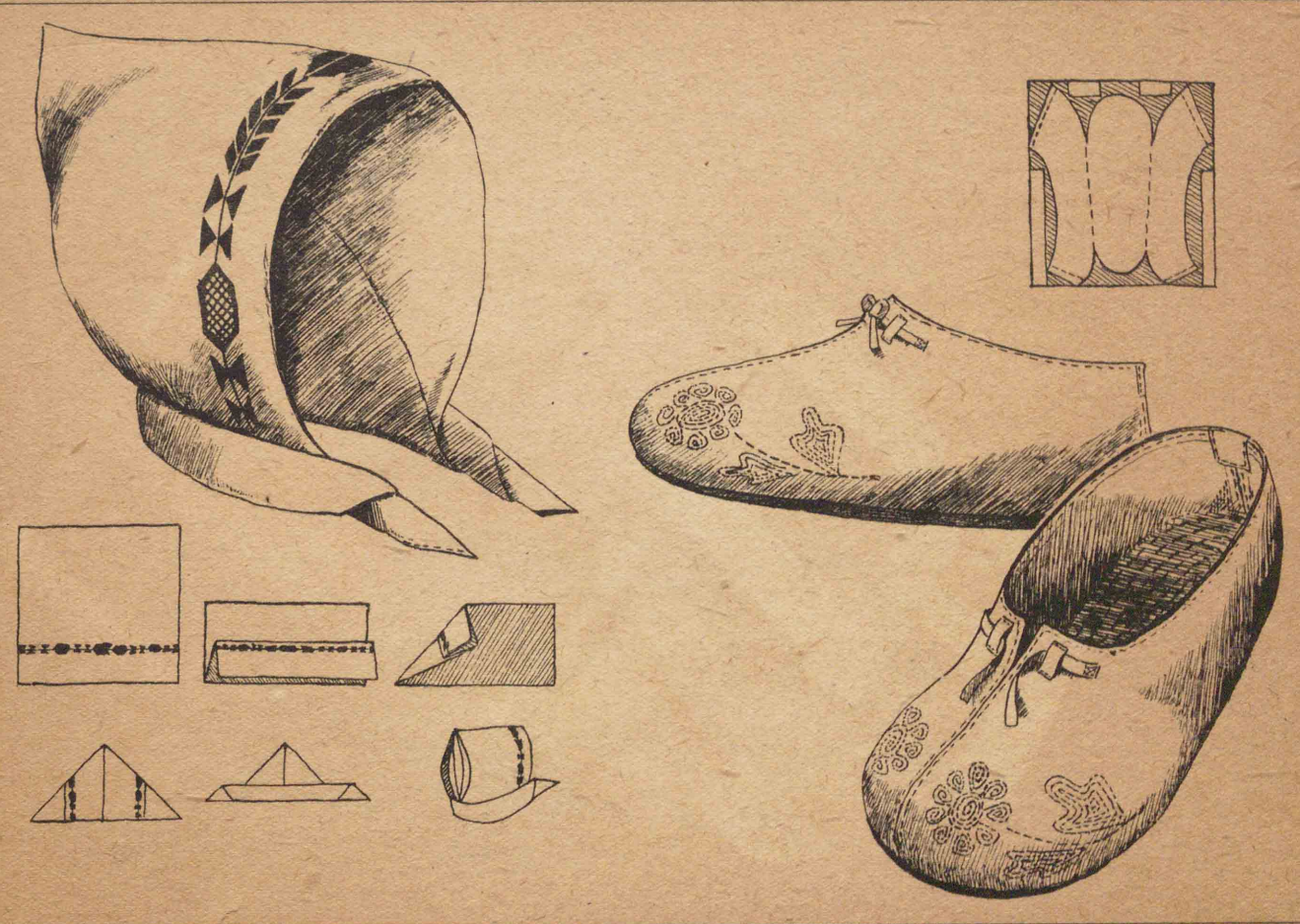

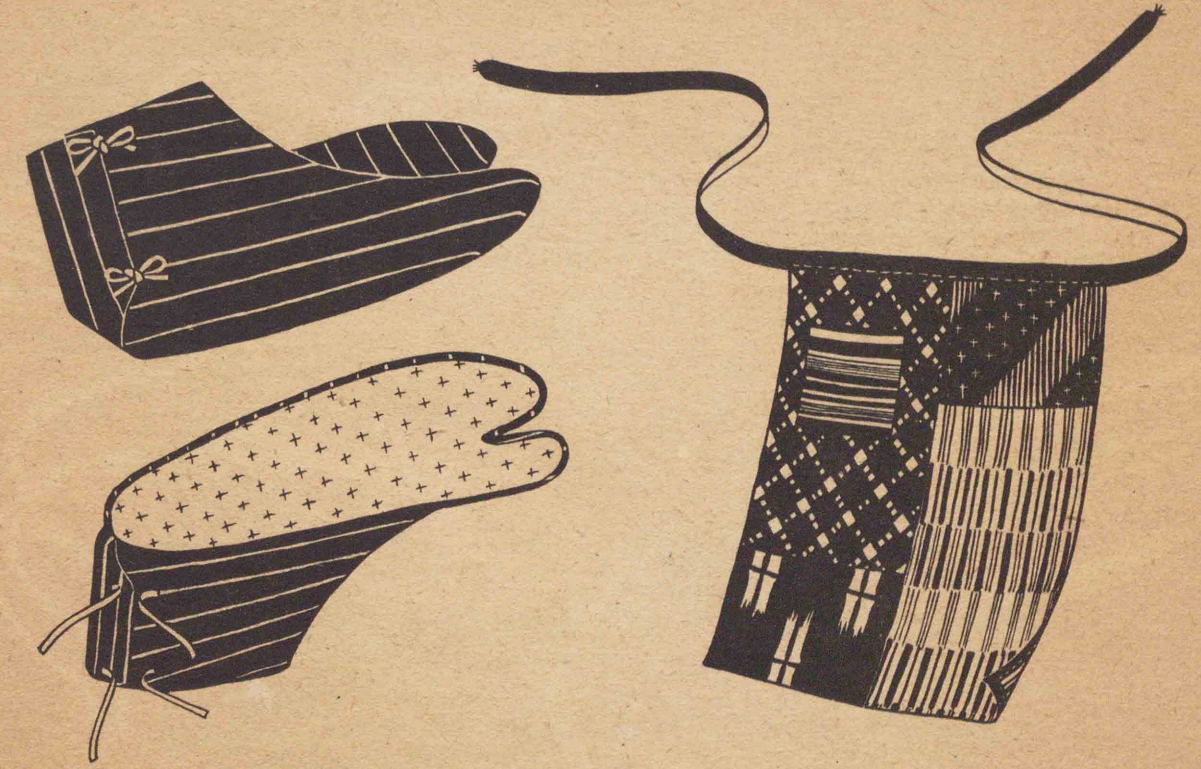

九、室内装置 その一

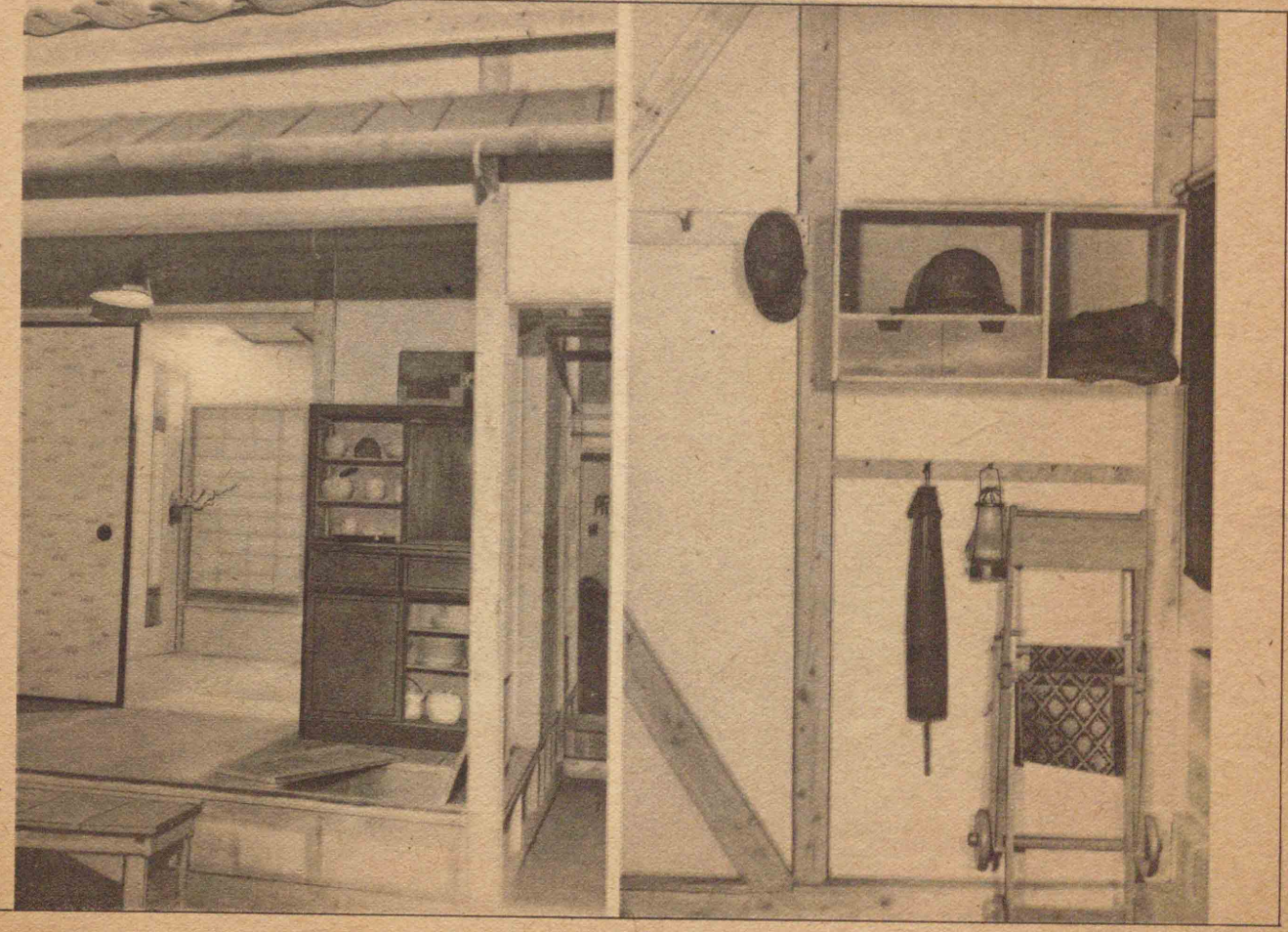

茶たんす

食卓

火鉢

ざぶとん

(坐る位置)

時計

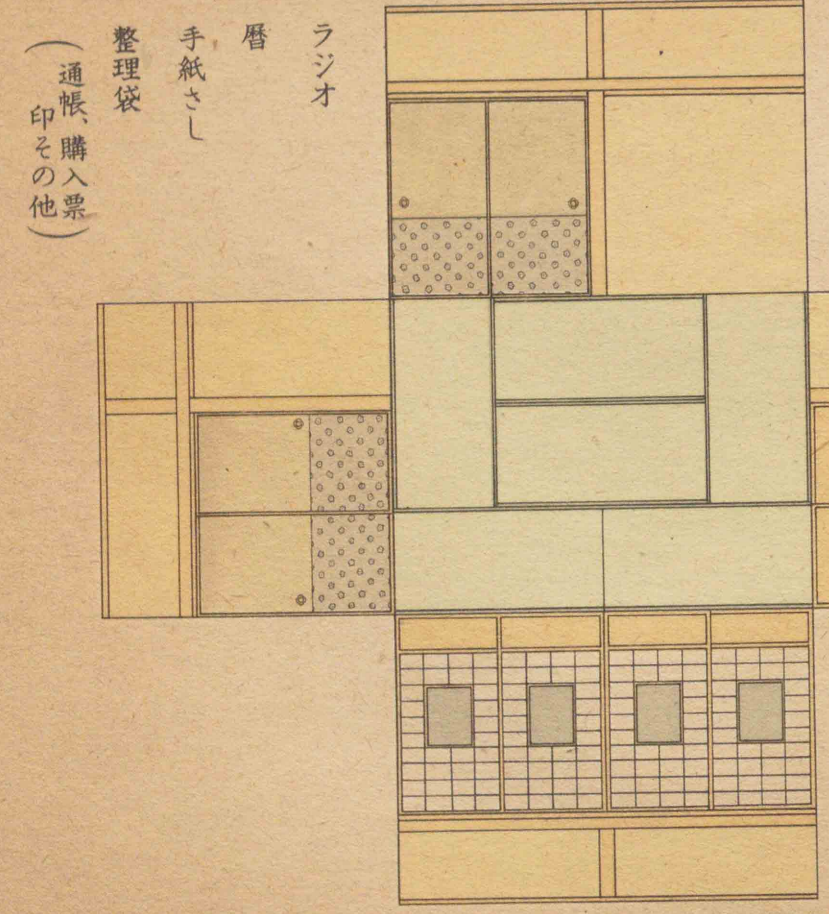

ラジオ

暦

手紙さし

整理袋

(通帳、購入票、印その他)

室内装置 その二

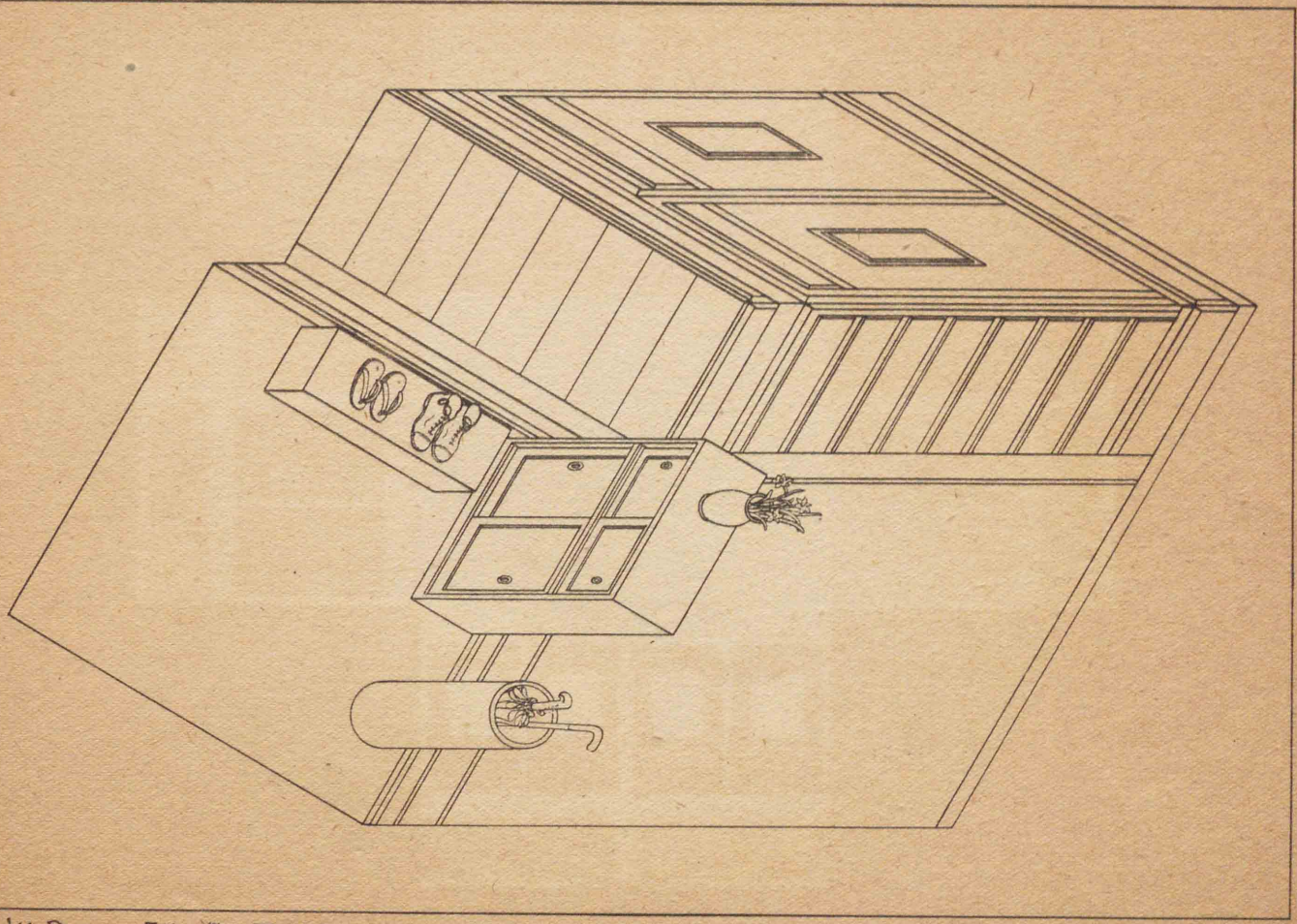

室内装置 その三

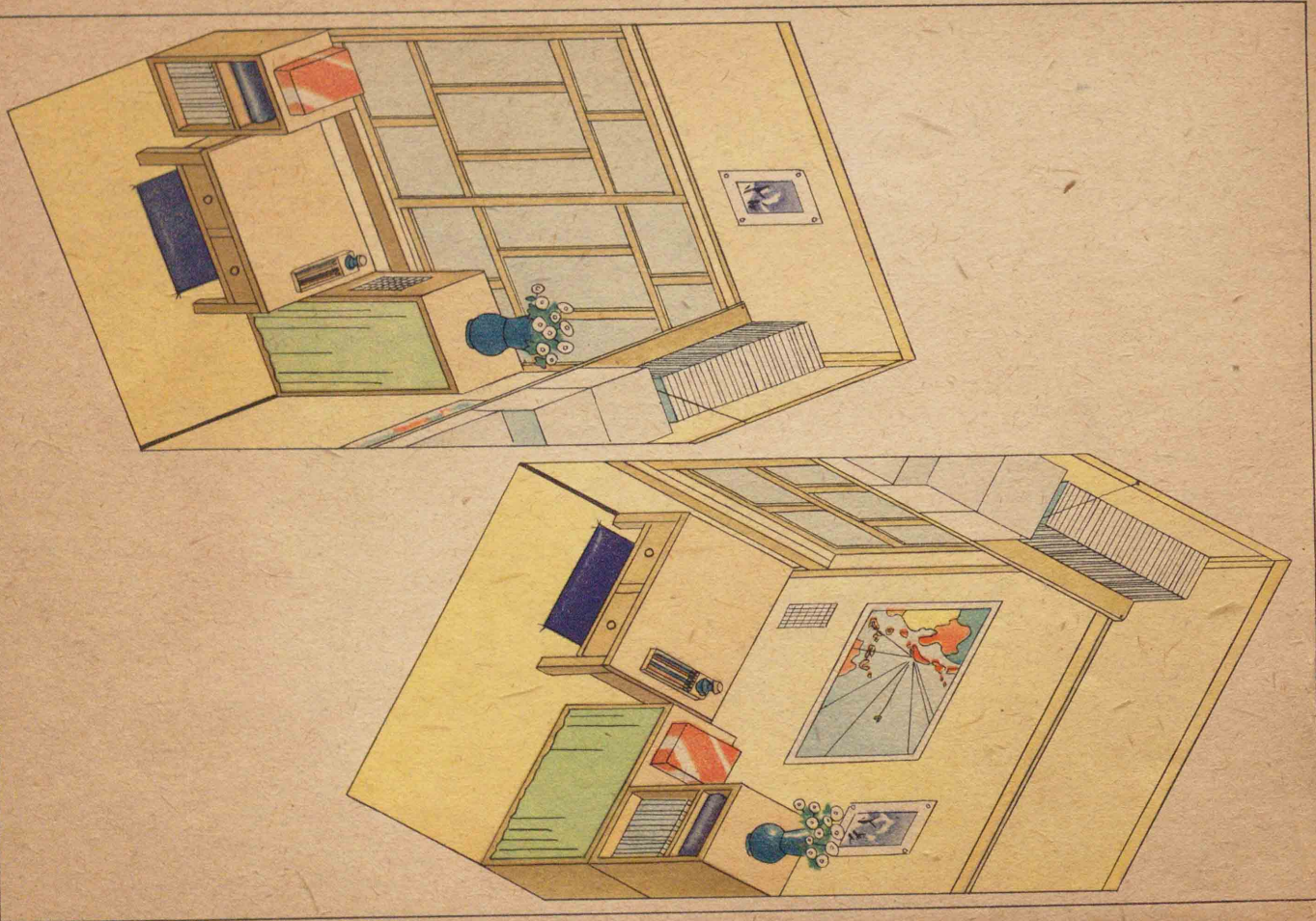

室内装置 その四

ミシン

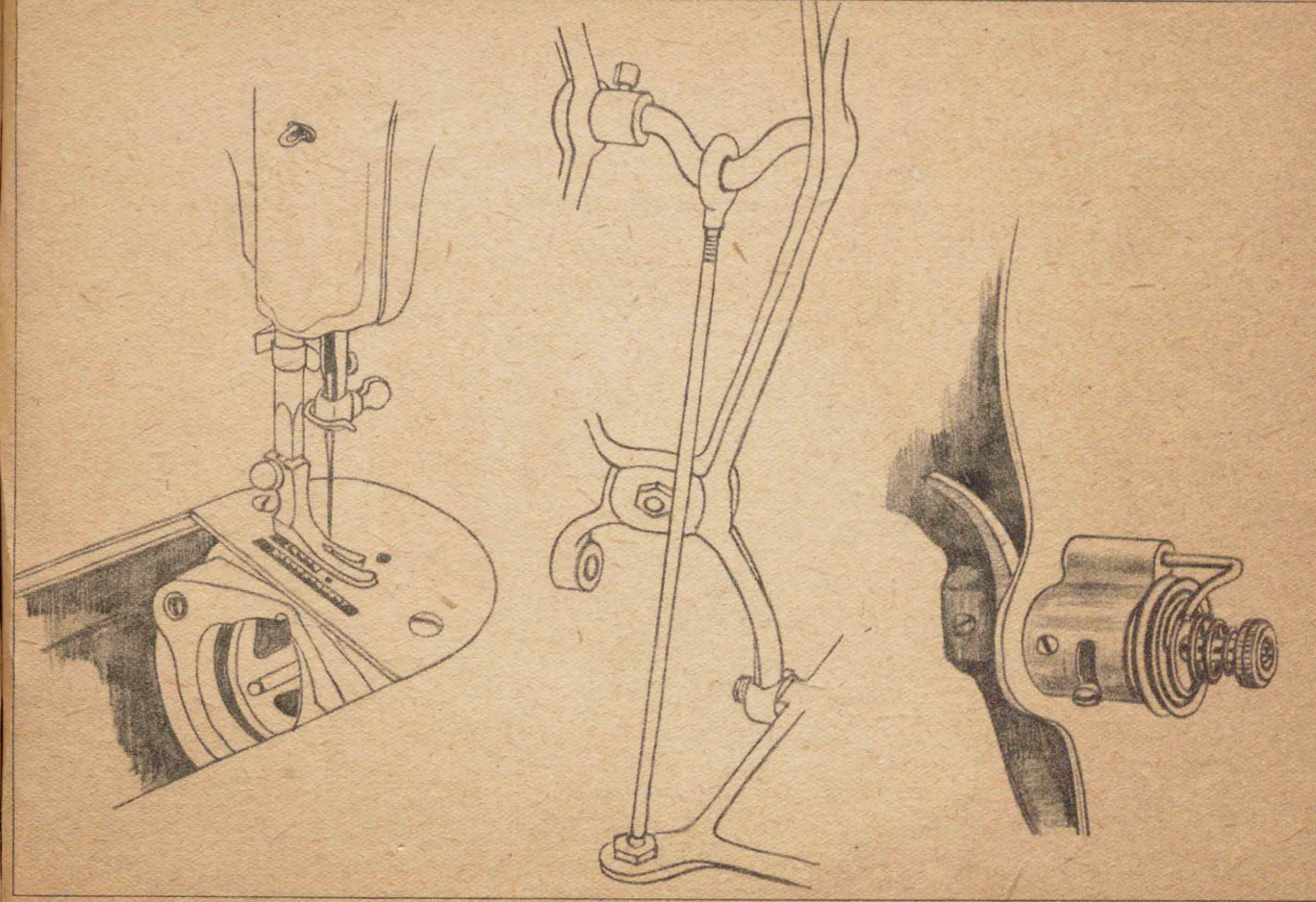
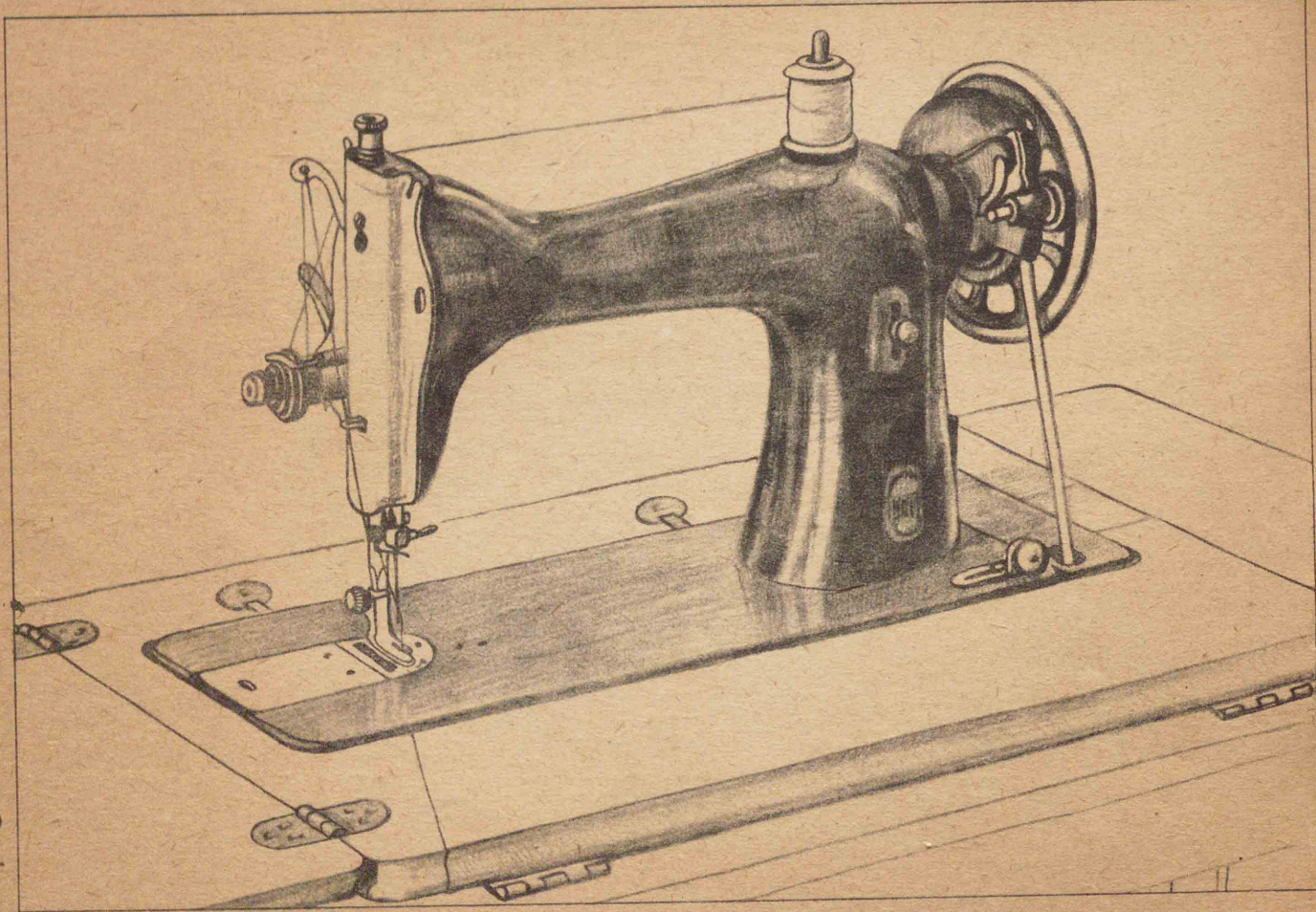

十、ミシンの構造

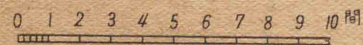
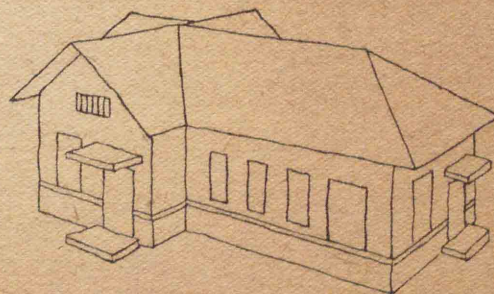
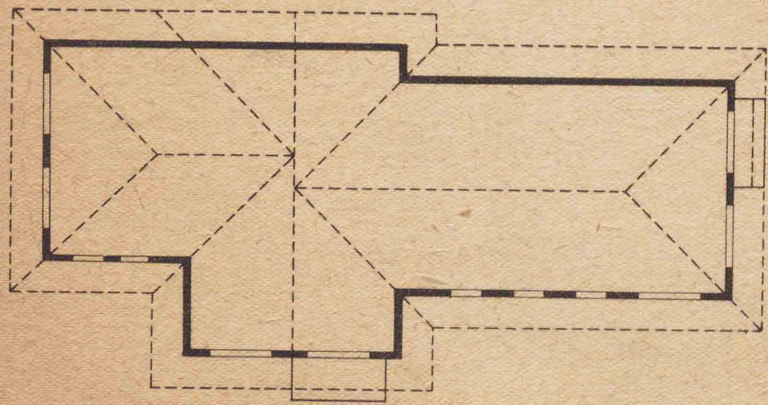
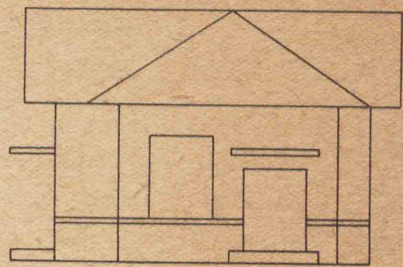
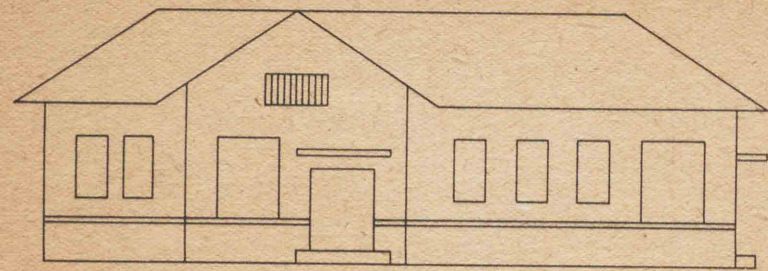
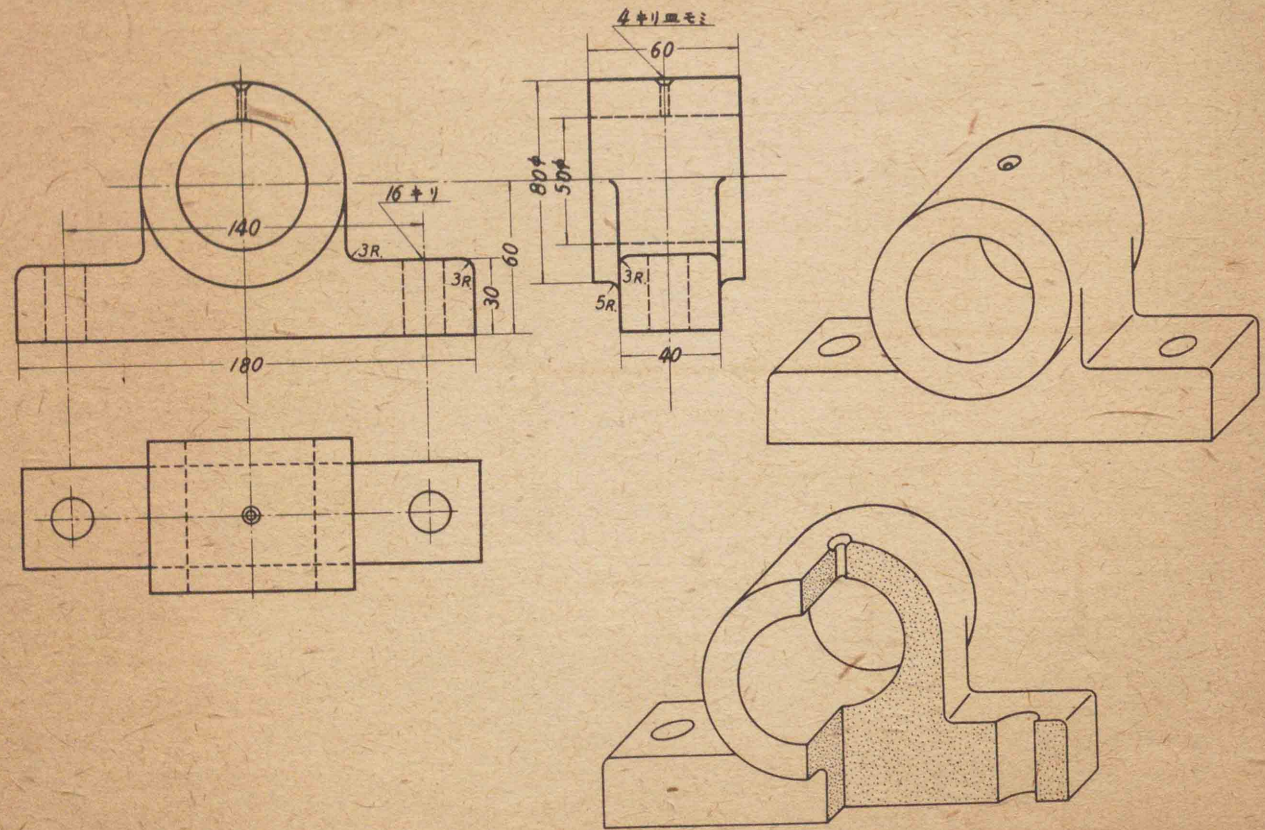





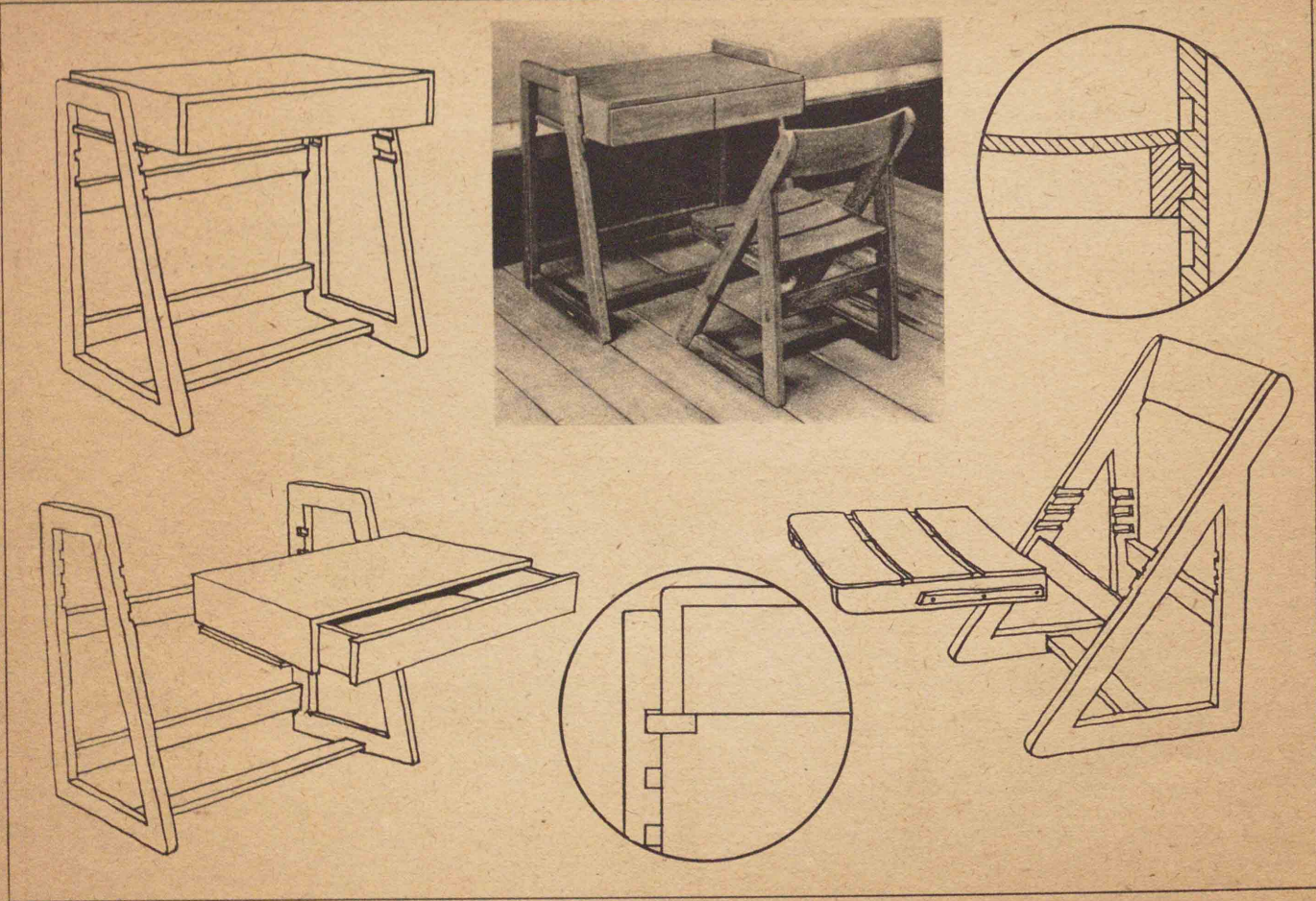

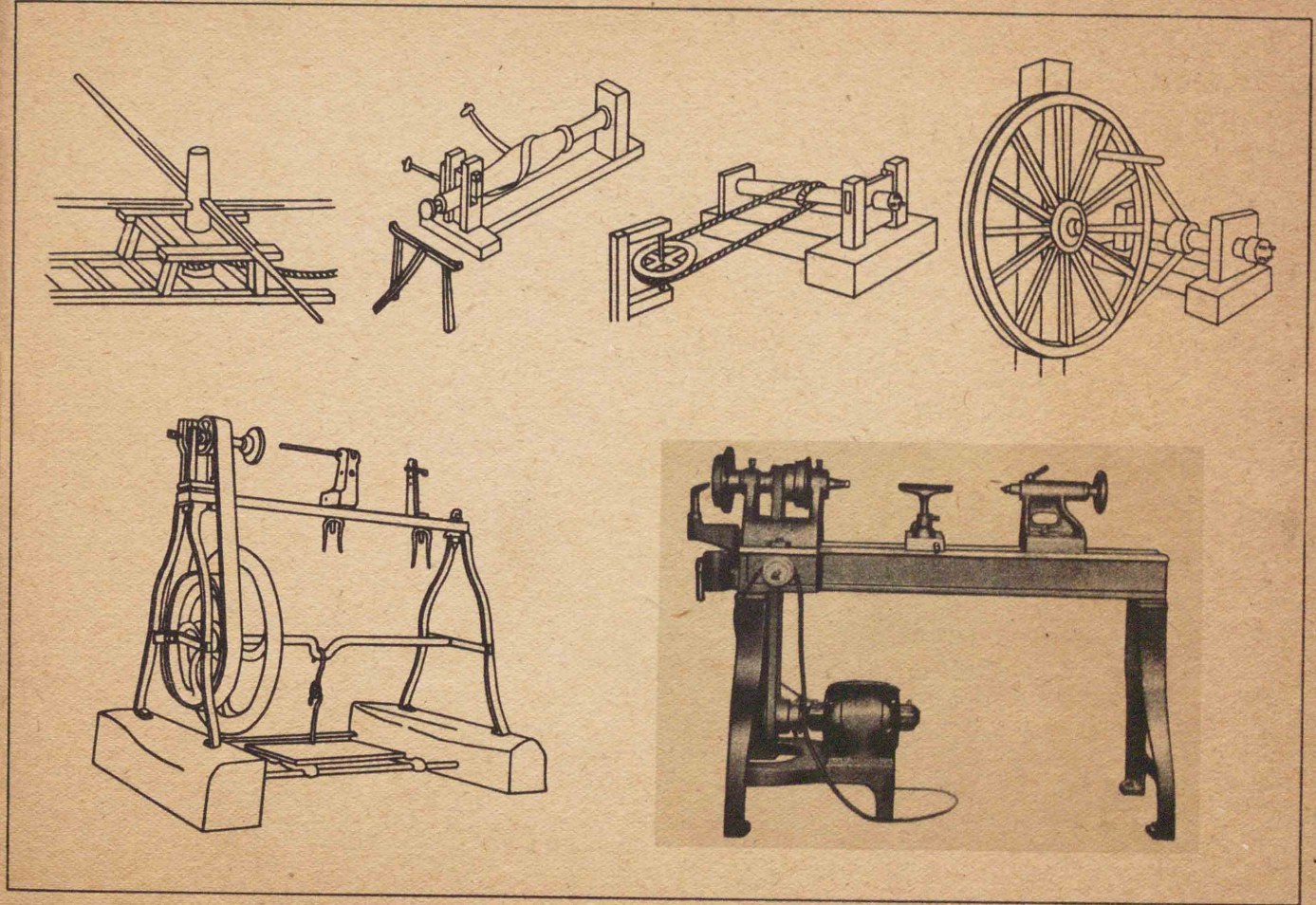

昭和十九年六月十八日  
 昭和十九年六月廿一日  
 昭和十九年七月三日

印刷  
 發行  
 翻刻印刷  
 翻刻發行

高等科圖畫一女子用か  
 新 定價金參拾錢

著作權所有

著作兼  
 發行者

文 部 省

昭和十九年六月廿二日  
 文部省檢査日



東京都王子區堀船町一丁目八百五十七番地  
 翻刻發行 東京書籍株式會社  
 兼印刷者 代表者 井上源之丞  
 印刷所 凸版印刷株式會社  
 東京都下谷區二長町一番地

發行所

東京書籍株式會社

広島大学図書

2000035891

