

40643

教科書文庫

4
710
31-1943
20000 15889

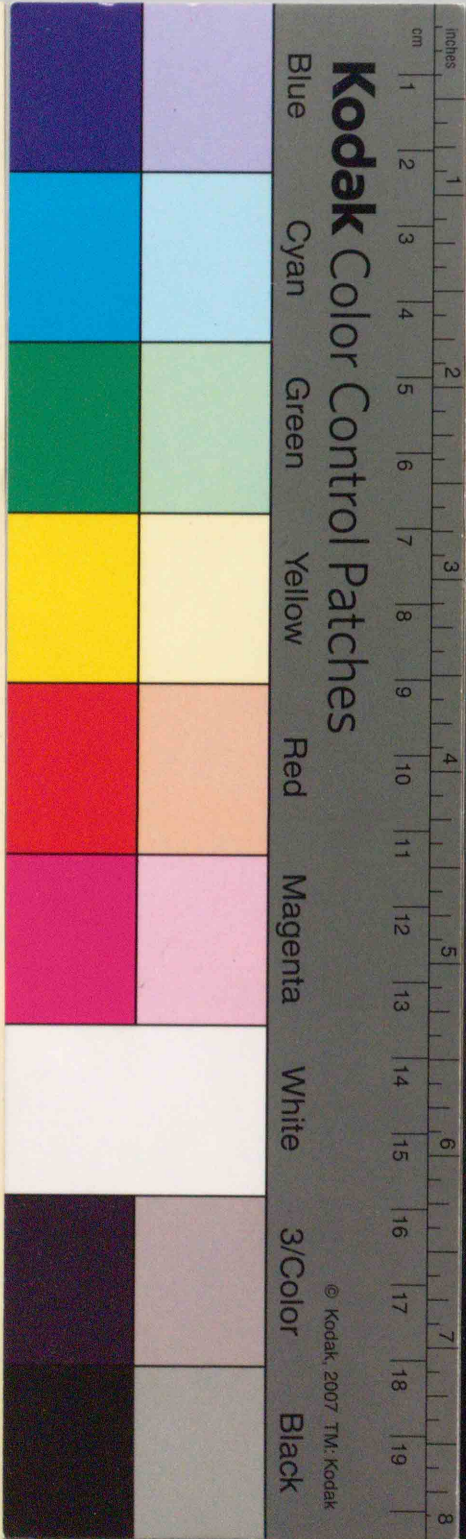

A 1 2 3 4 5 6 M 8 9 10 11 12 13 14 15 B 17 18 19

Kodak Gray Scale



© Kodak, 2007 TM: Kodak

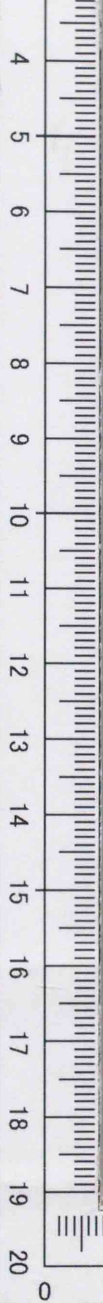

教科書文庫
4
710
31-1943
2000015889

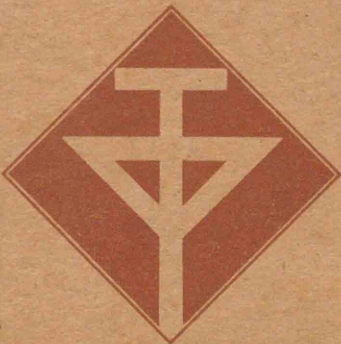

文
部
省

広島大学図書
2000015889

初等科工作三

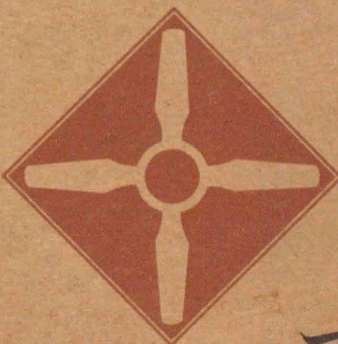

女子用



375.9
M214

資料室

教科書文庫

4

710

31-1943

2000015889

初等科工作三



文部省

女子用

広島大学図書

2000015889



目 録

- | | |
|--------------------------|-------------|
| 1. ^{ノコギリ} 鋸ノ使ヒ方 | 7. 電氣器具ノ扱ヒ方 |
| 2. ^{カンナ} 鉋ノ使ヒ方 | 8. 舟 |
| 3. ^{エモン} 衣紋掛 | 9. ヒモ |
| 4. 手サゲノロ | 10. 辨當袋 |
| 5. ^{コト} 琴 | 11. 靴下カバー |
| 6. 飛行機 | |

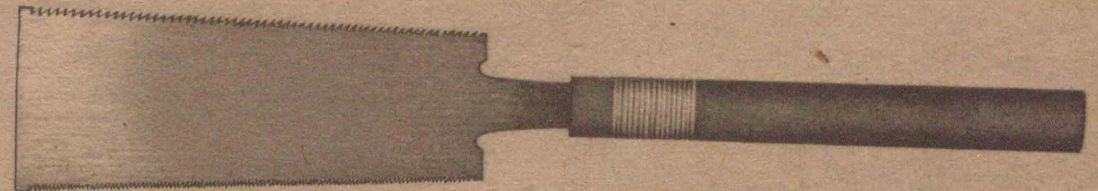
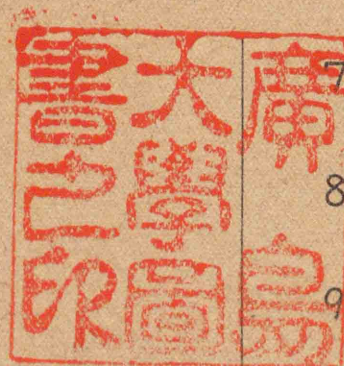

①

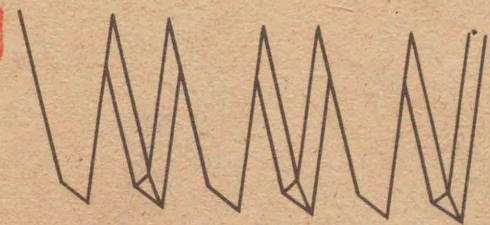

②

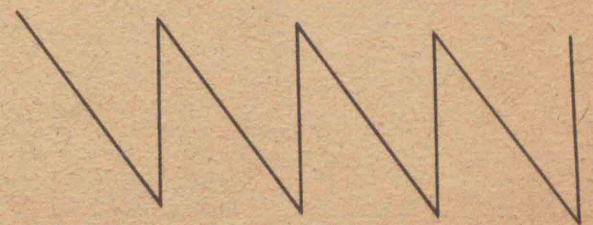

1. 鋸ノ使ヒ方 ソノ一

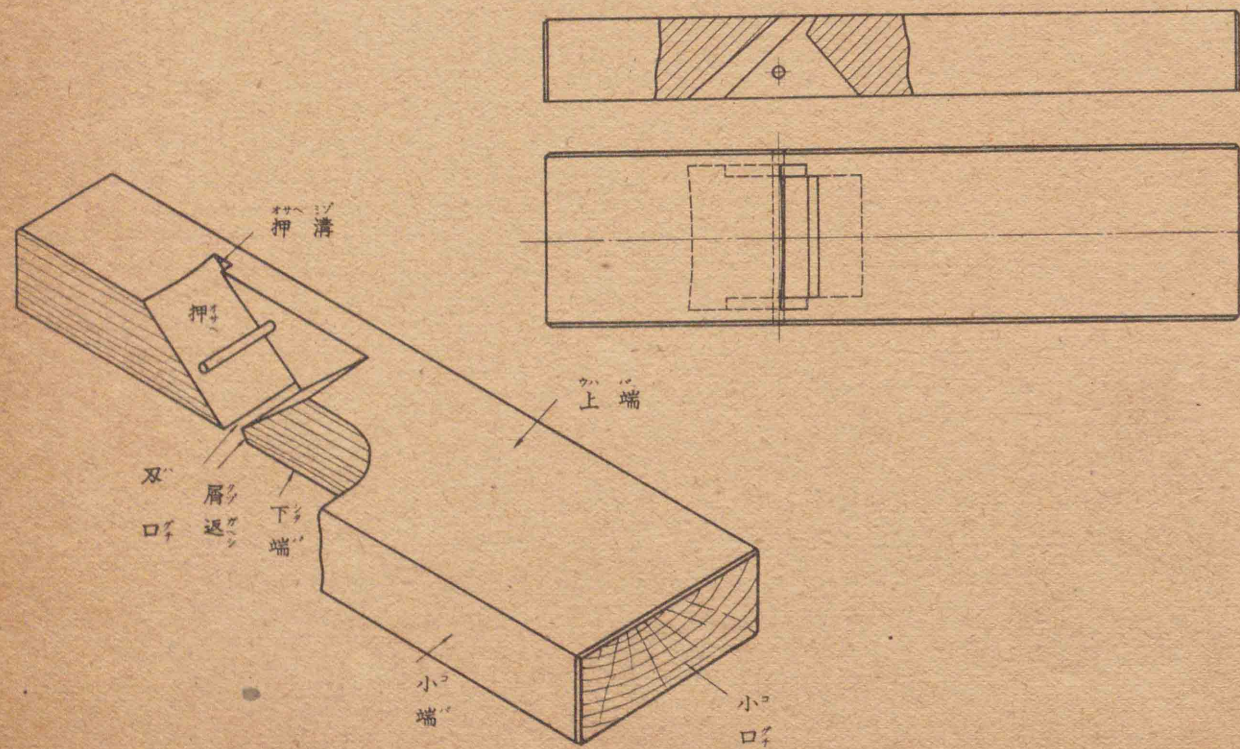

2. 鉋ノ使ヒ方 ソノ一

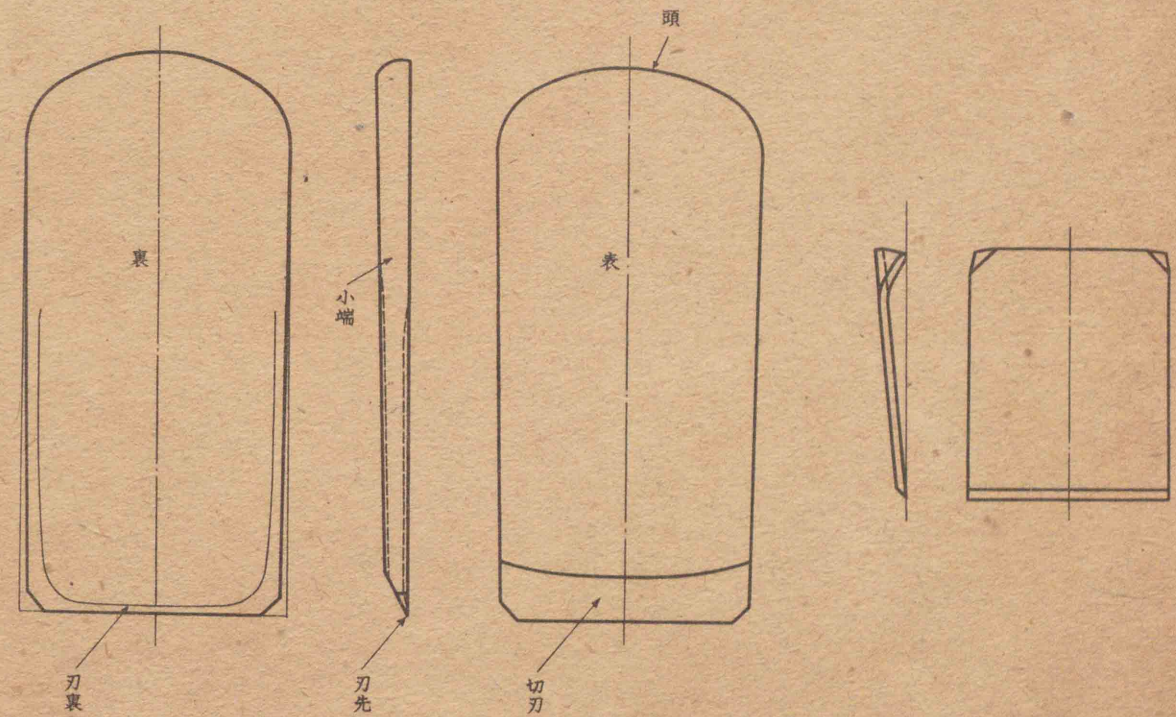

鉋ノ使ヒ方 ソノニ

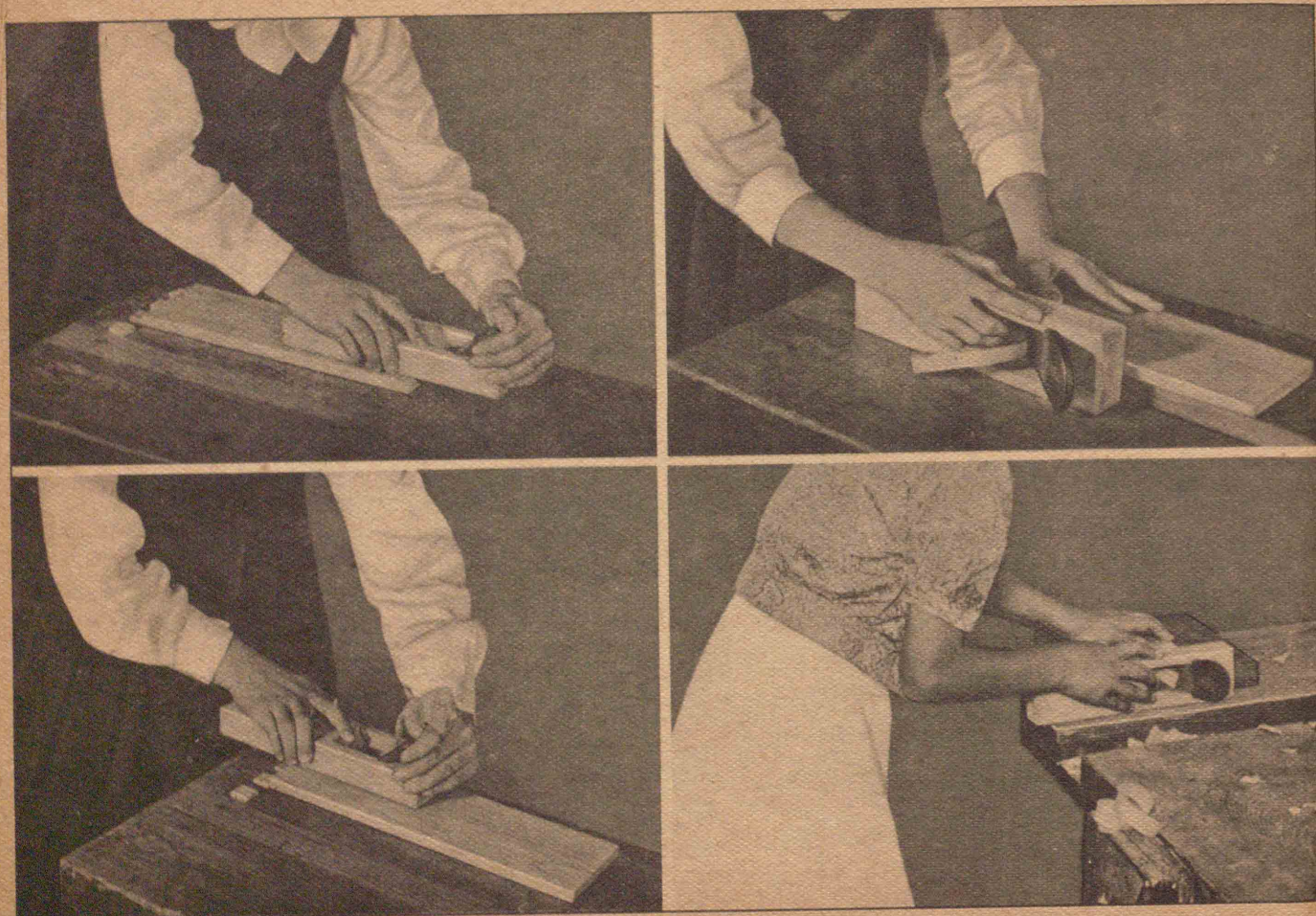

鉋ノ使ヒ方 ソノ三

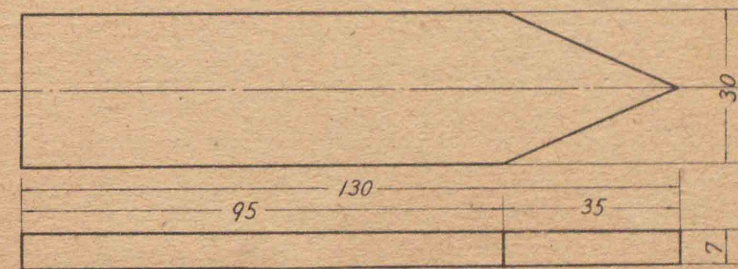
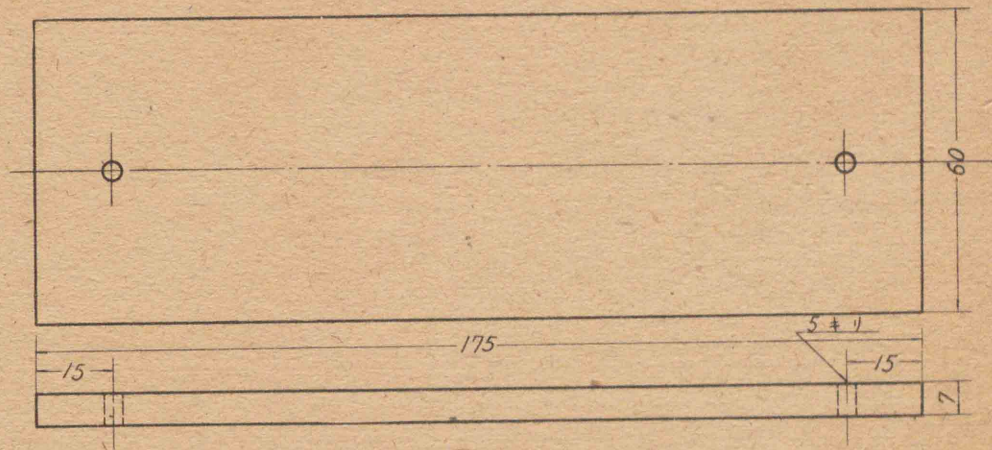

鉋ノ使ヒ方 ソノ四

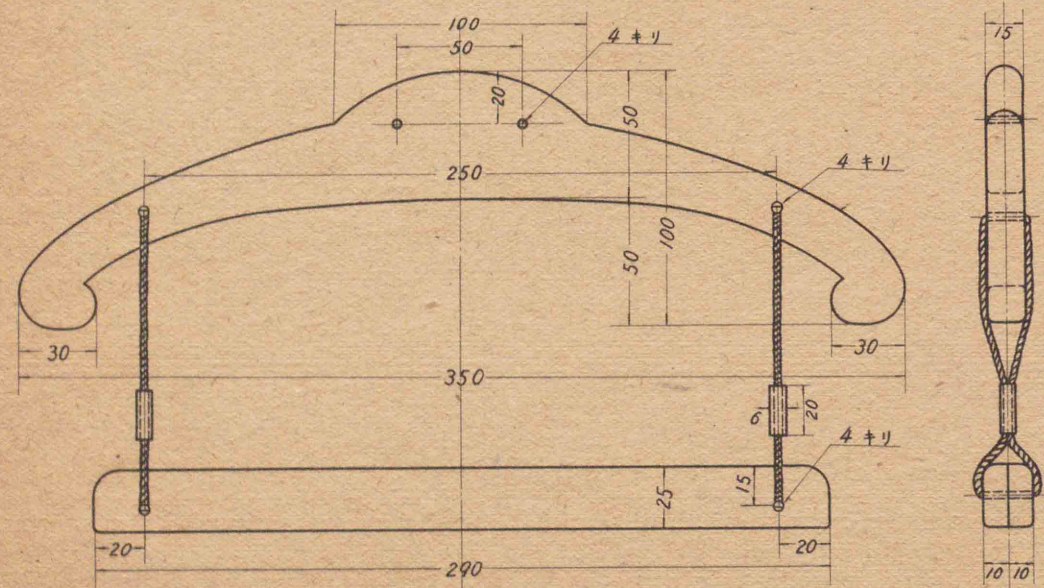

3. 衣紋掛 ソノ一

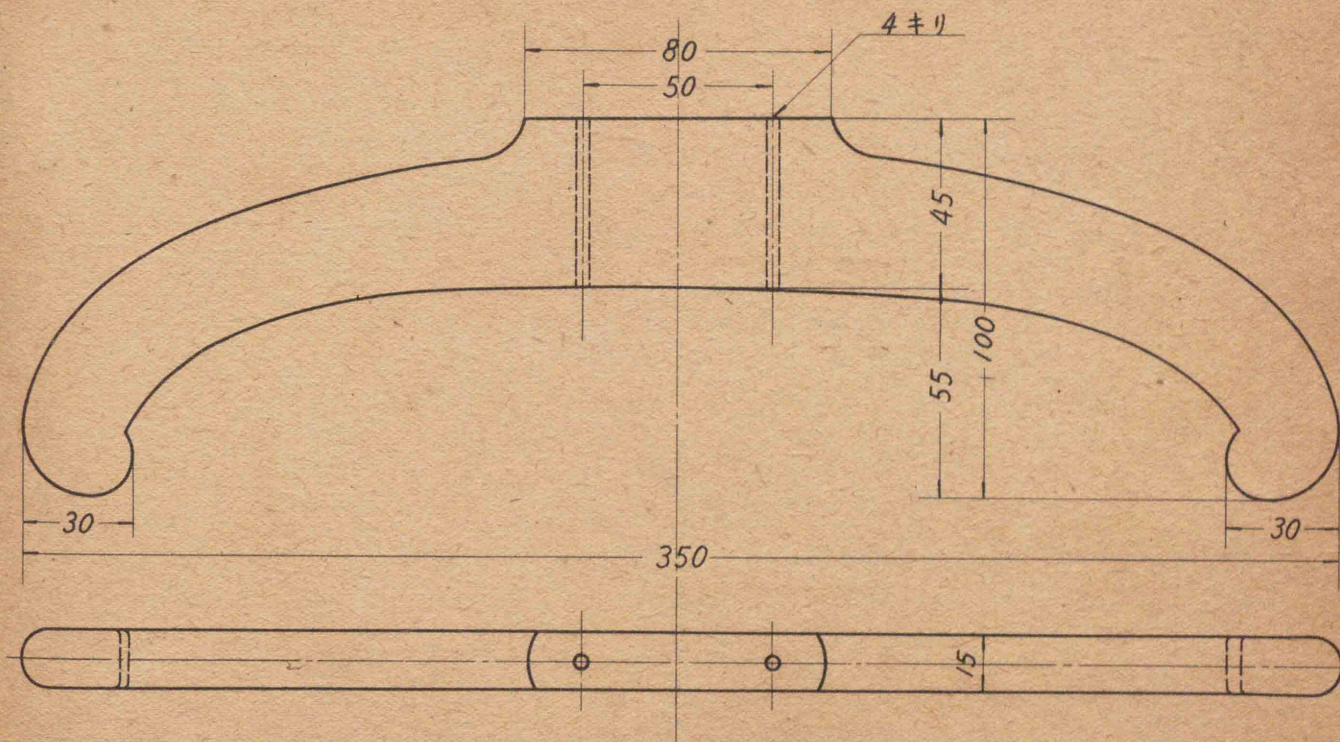

衣紋掛 ソノニ



衣紋掛 ソノ三

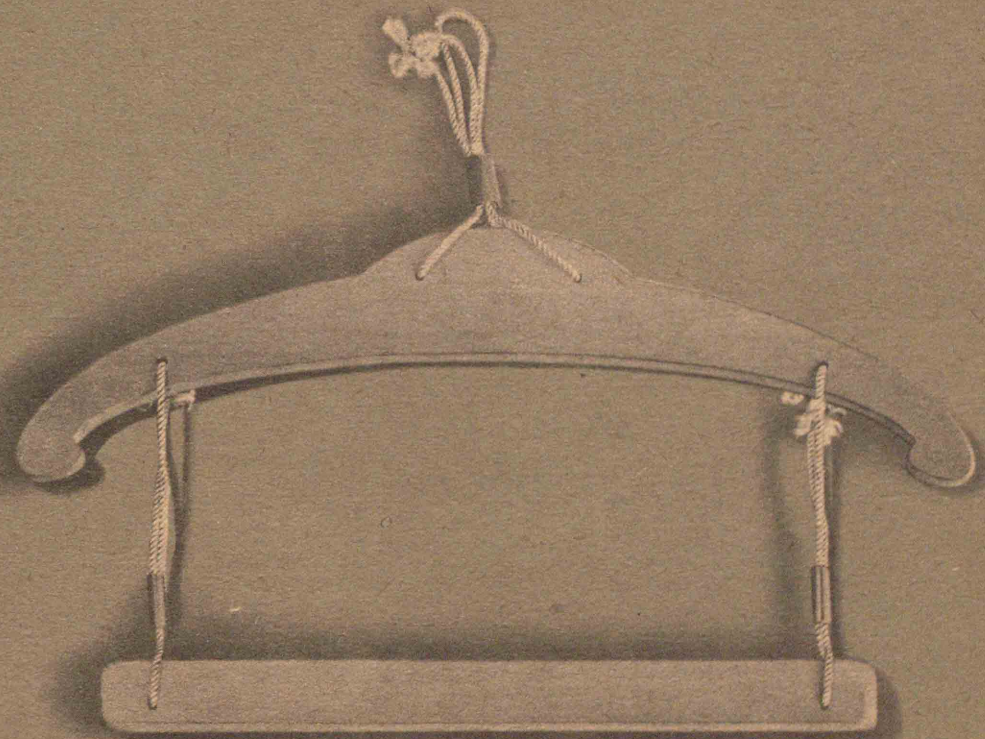

衣紋掛 ソノ四

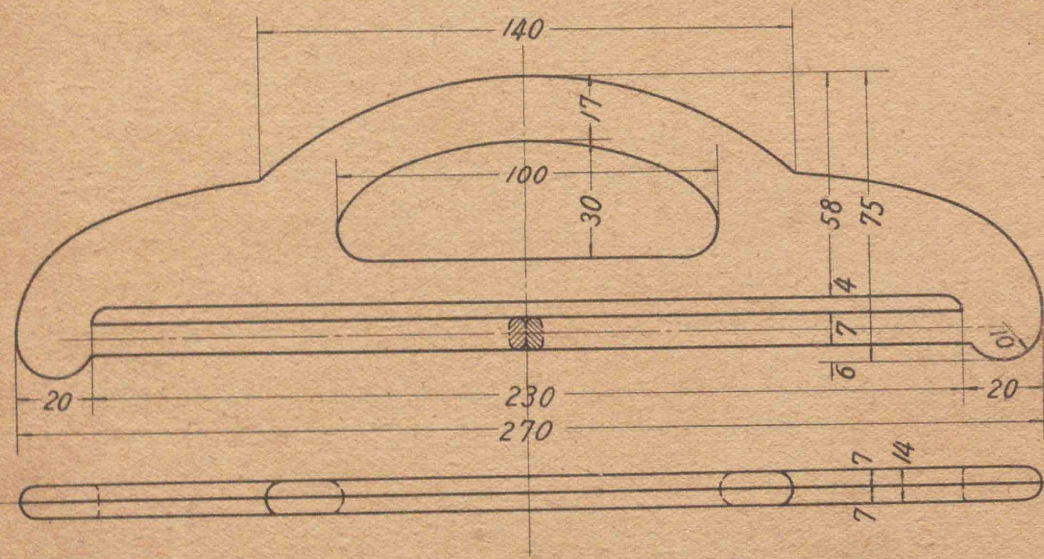

4. 手サゲノロ ソノ一

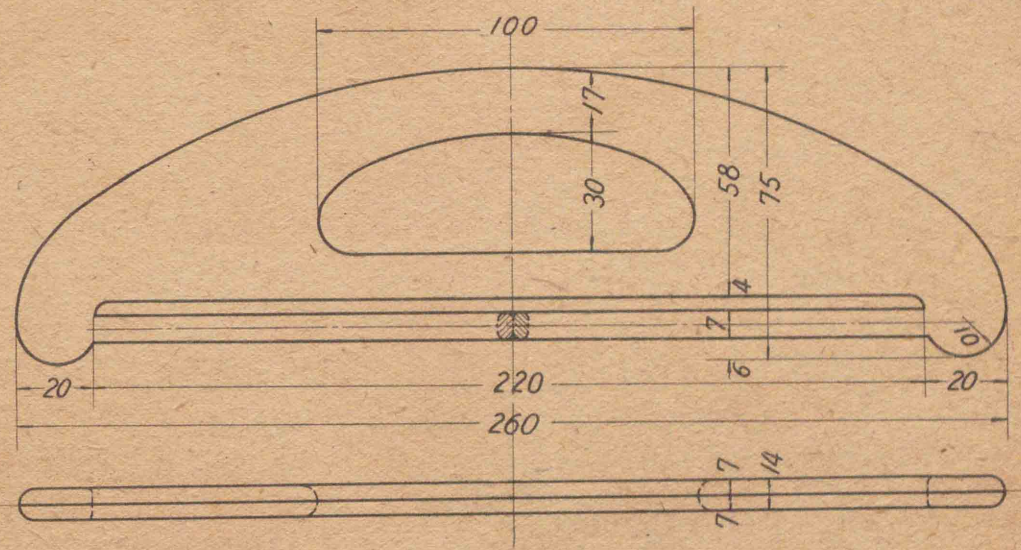

手サゲノロ ソノ二

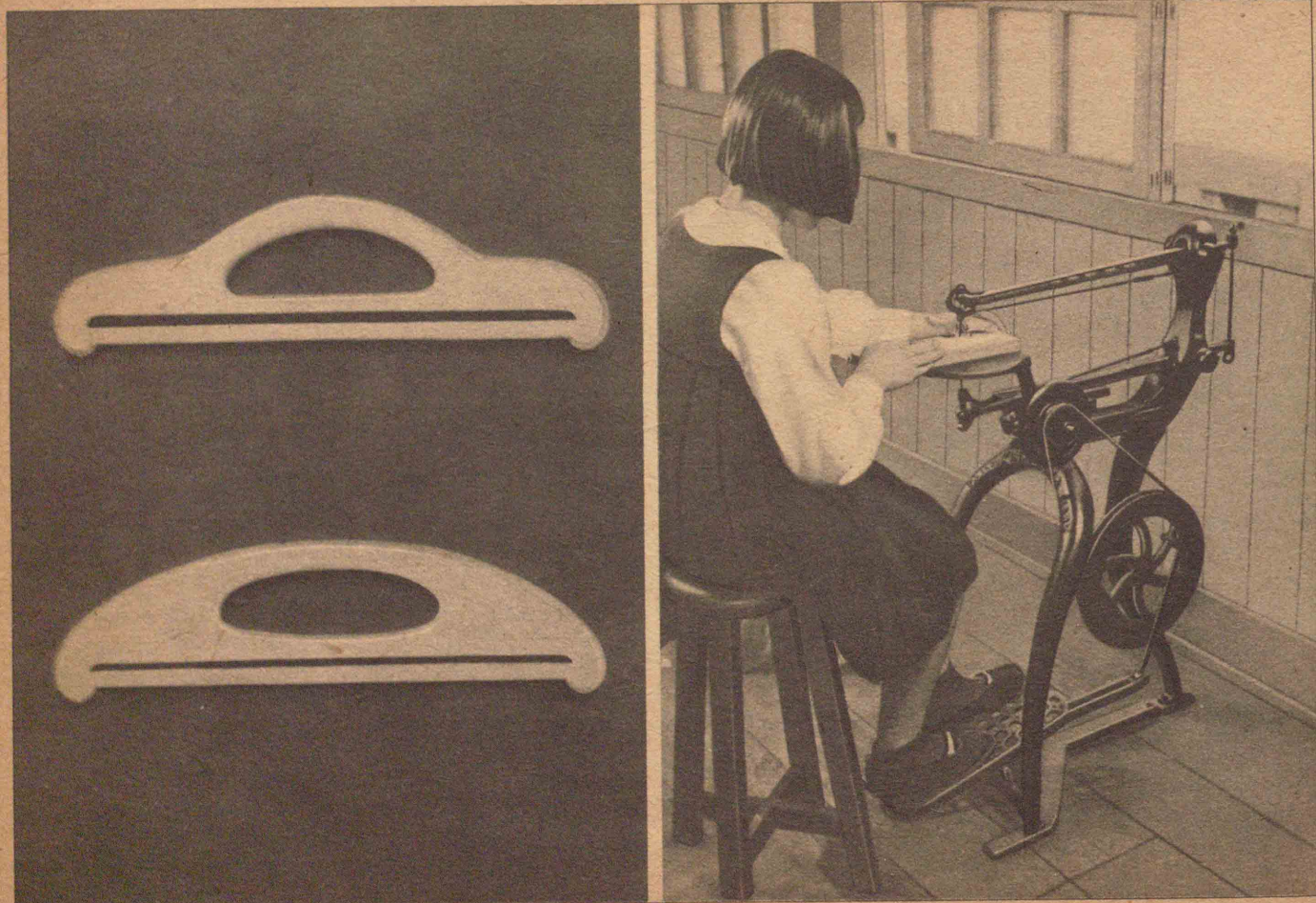

手サゲノロ ソノ三

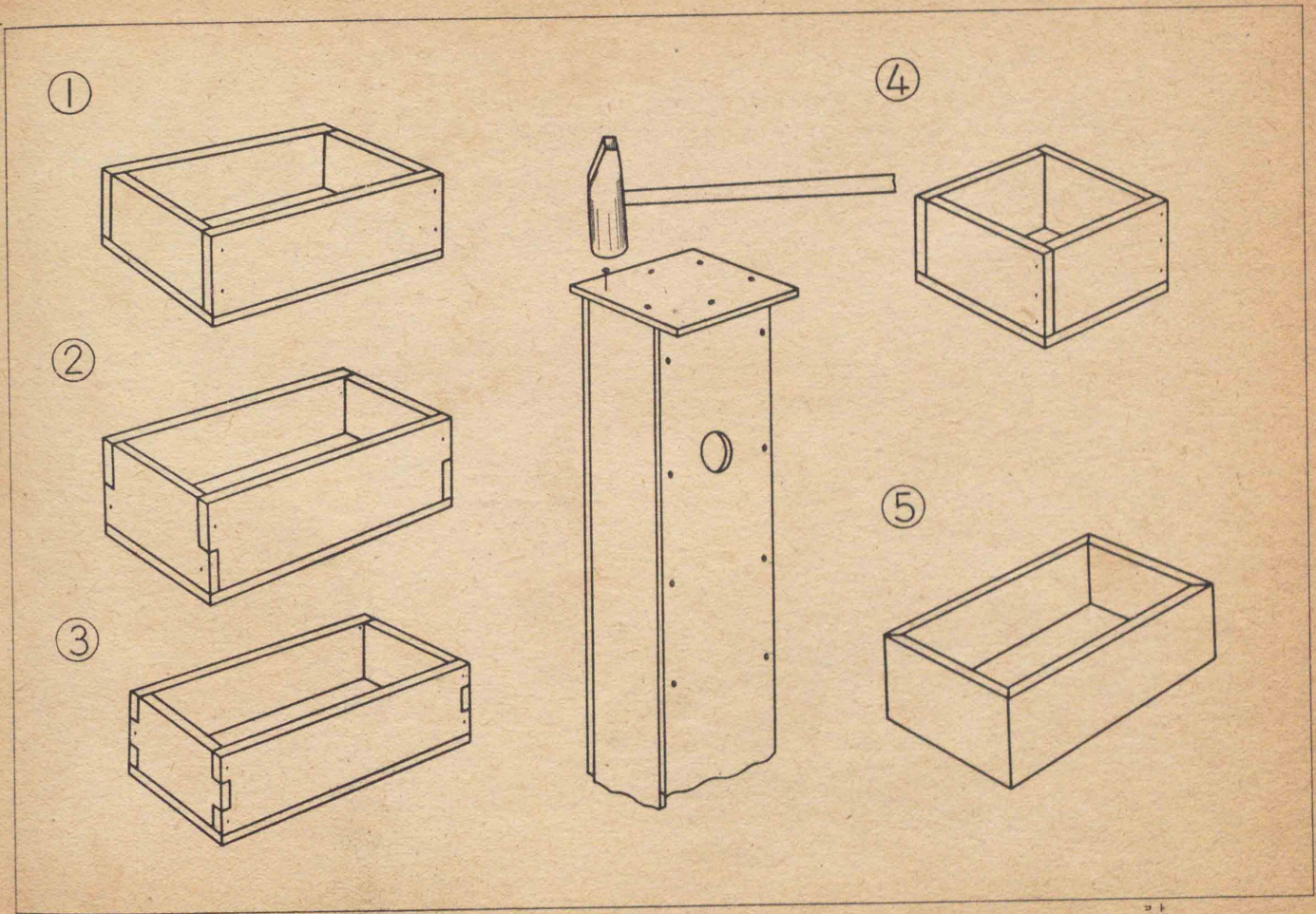

5. 琴ソノ

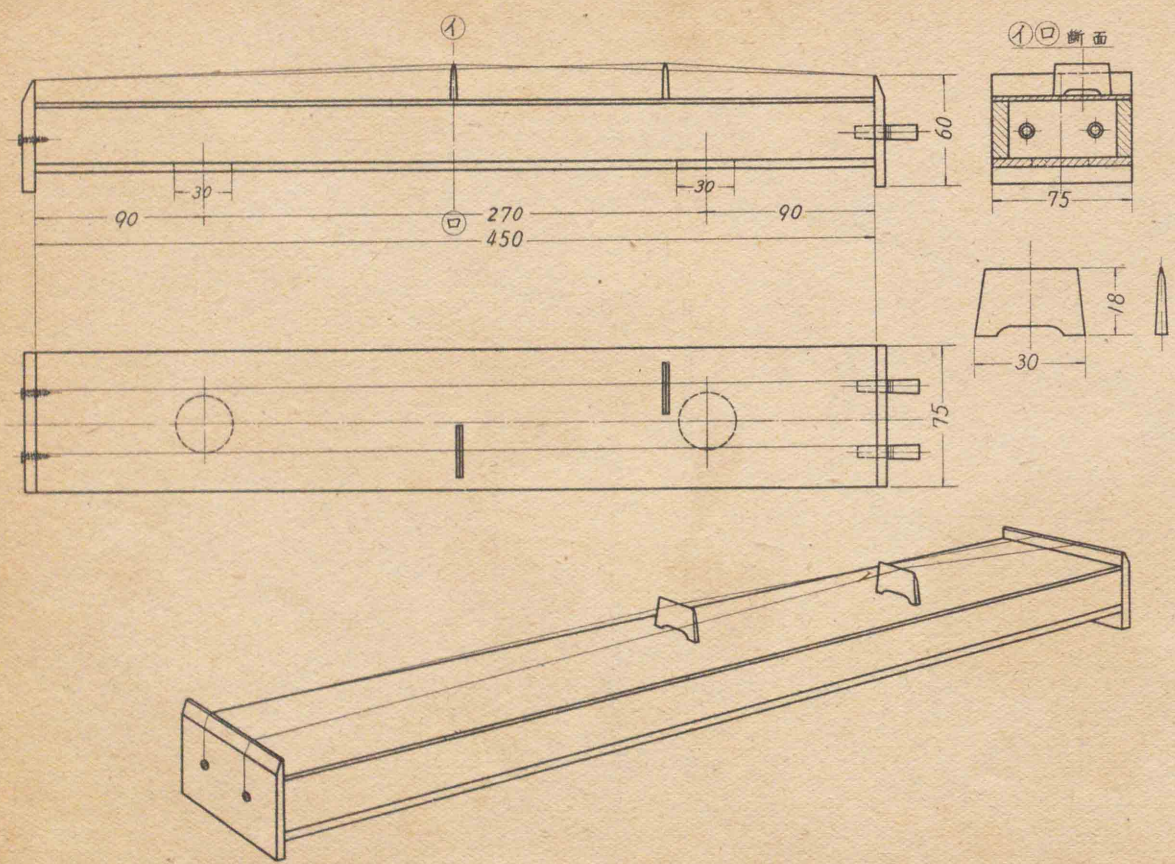

琴 ソノニ

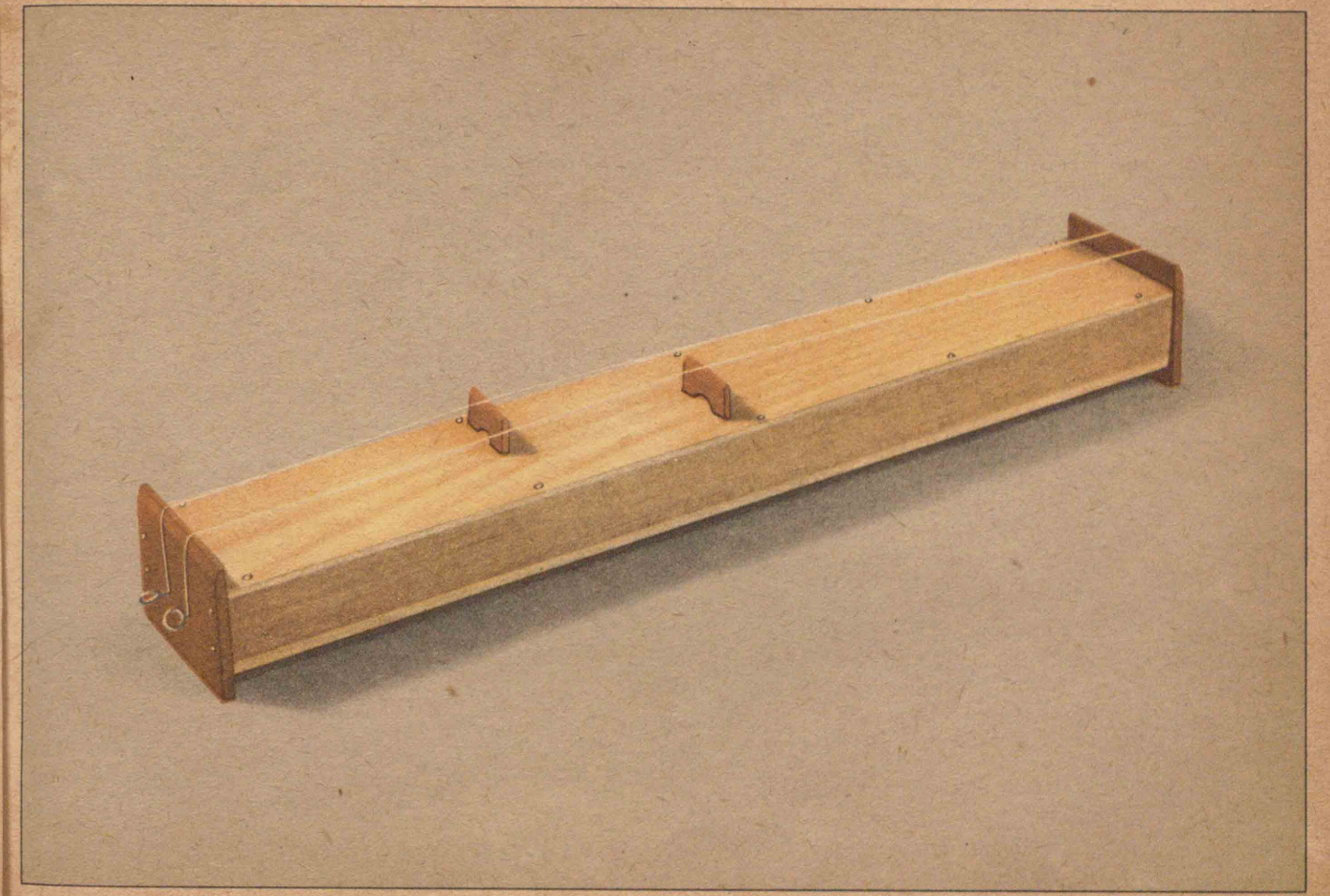

琴 ソノ三

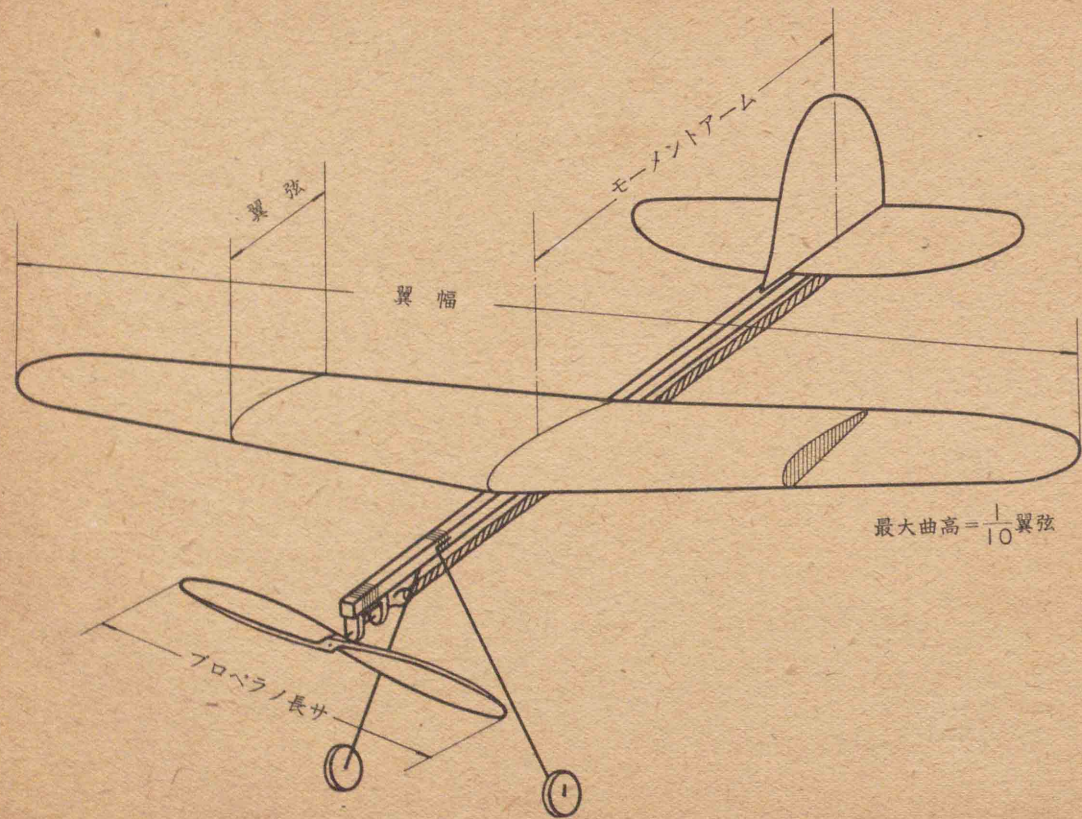

最大曲高 = $\frac{1}{10}$ 翼弦

6. 飛行機 ソノ一

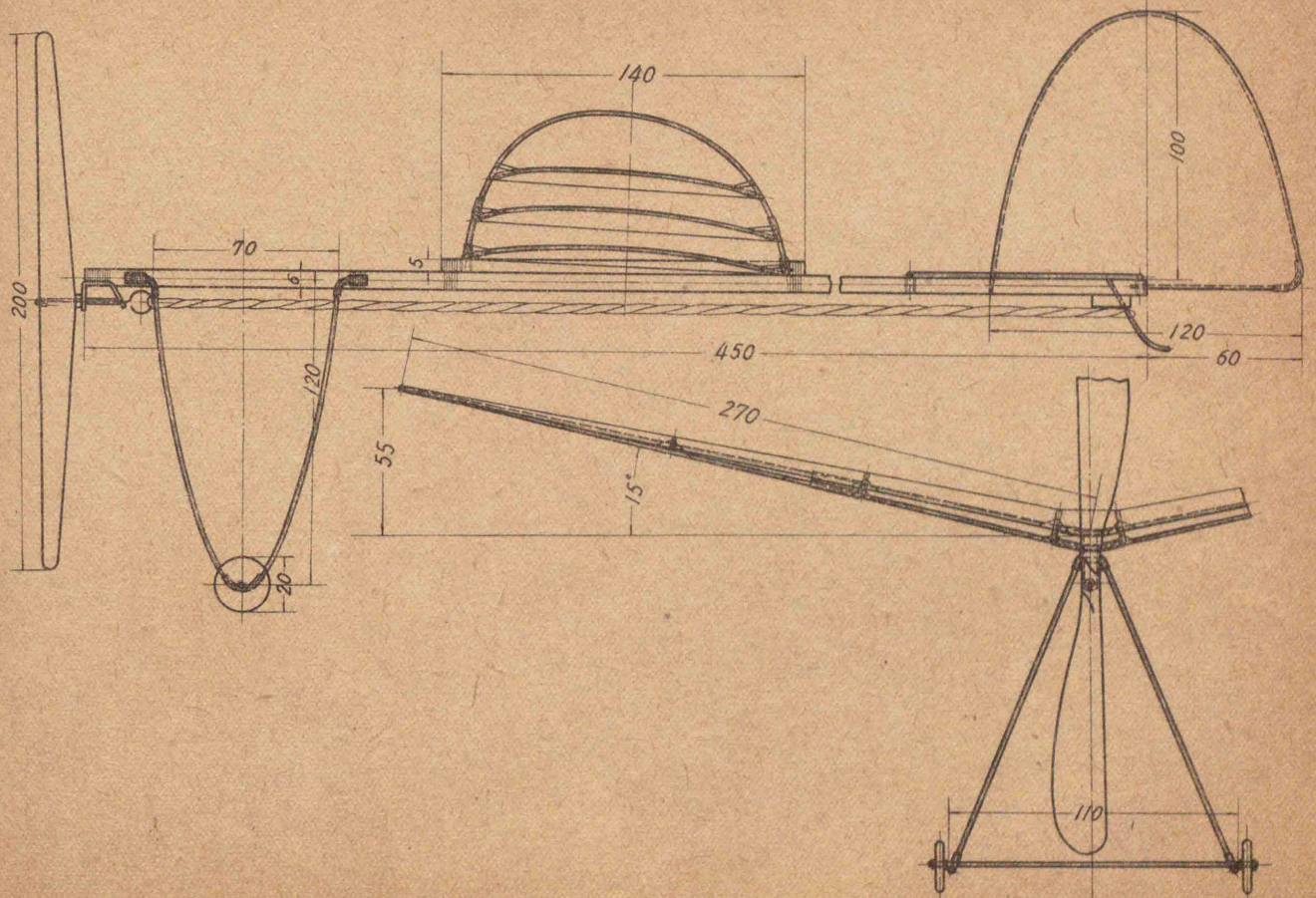

飛行機 ソノ二

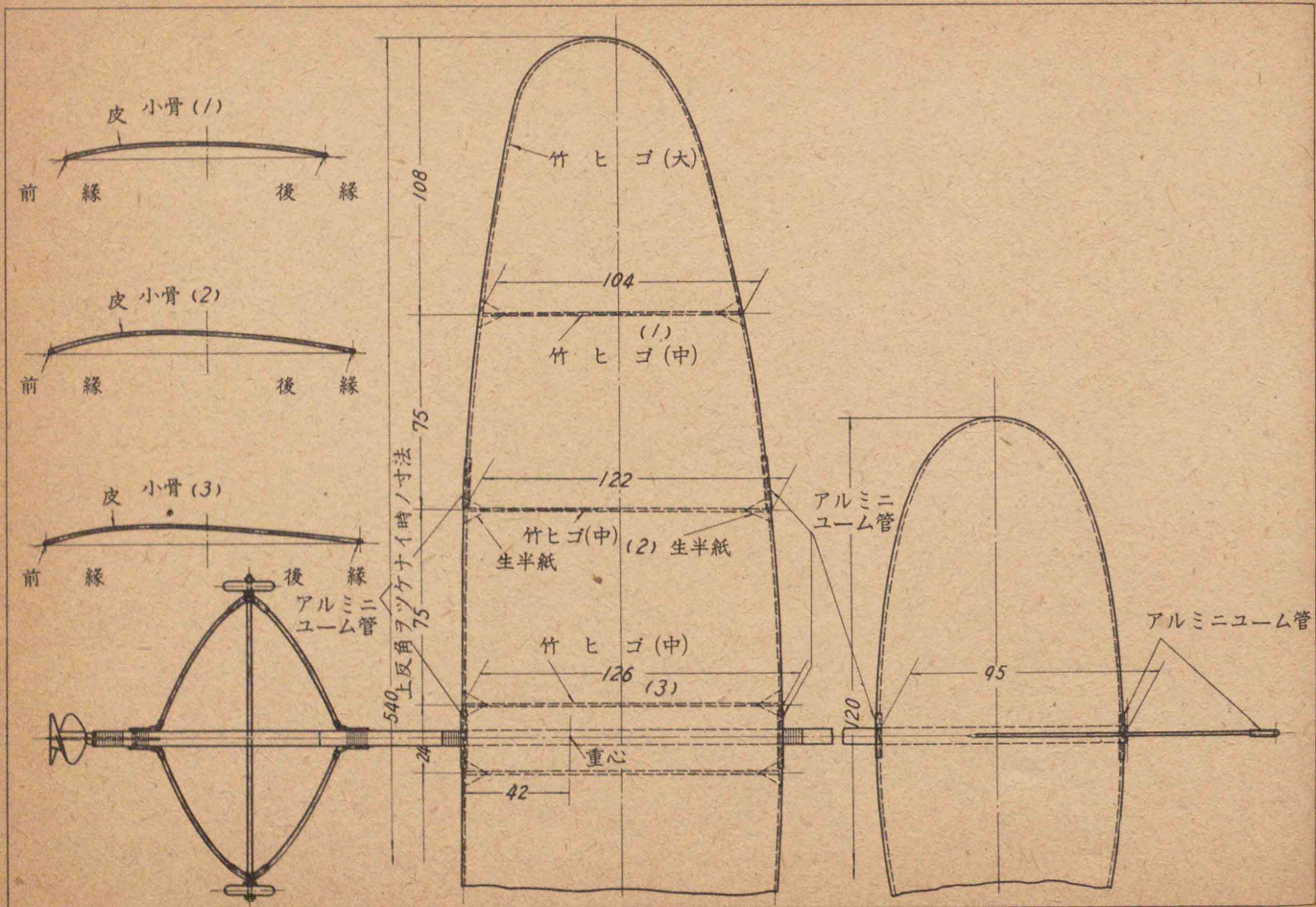

飛行機 ソノ三

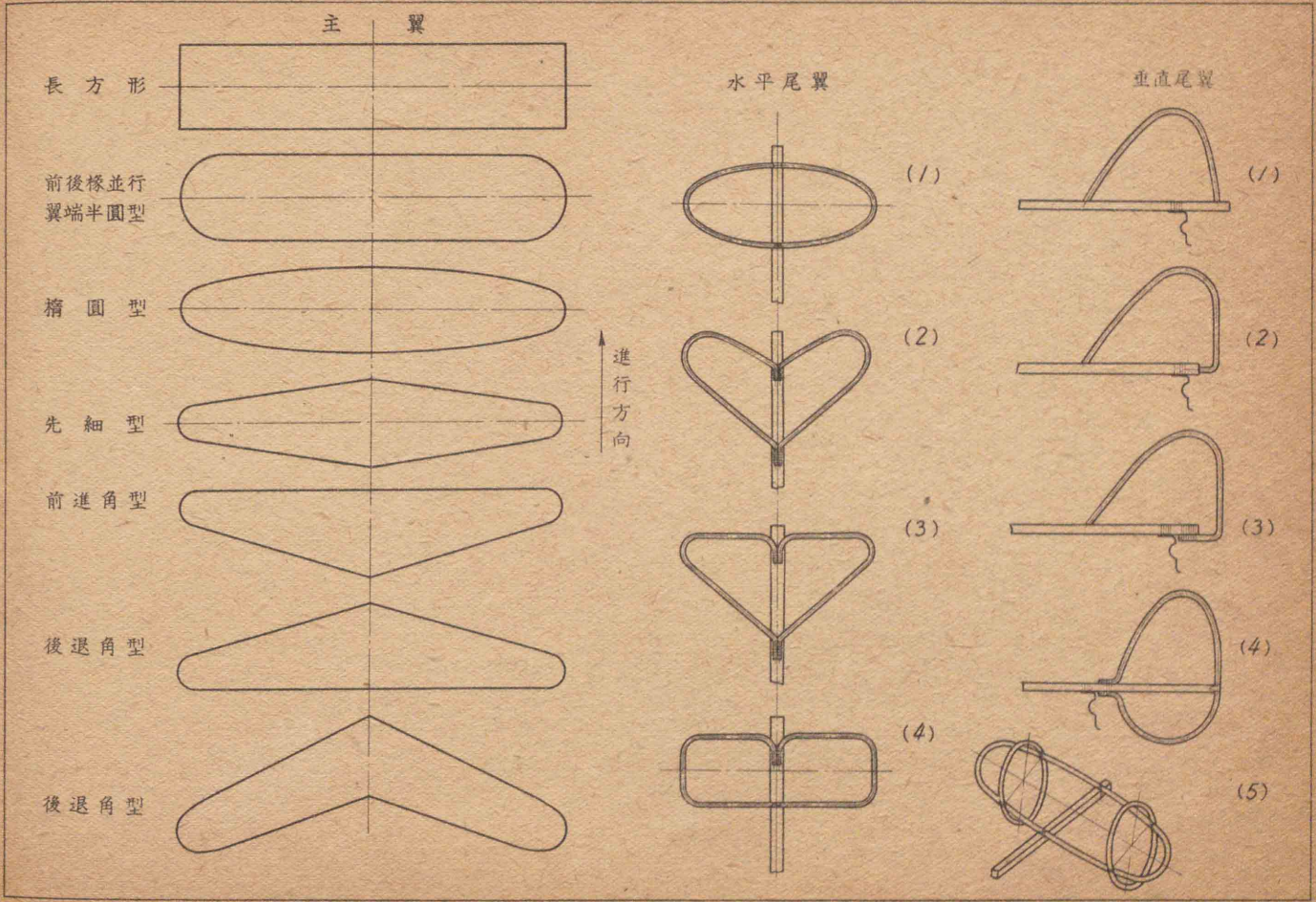

飛行機 ソノ四

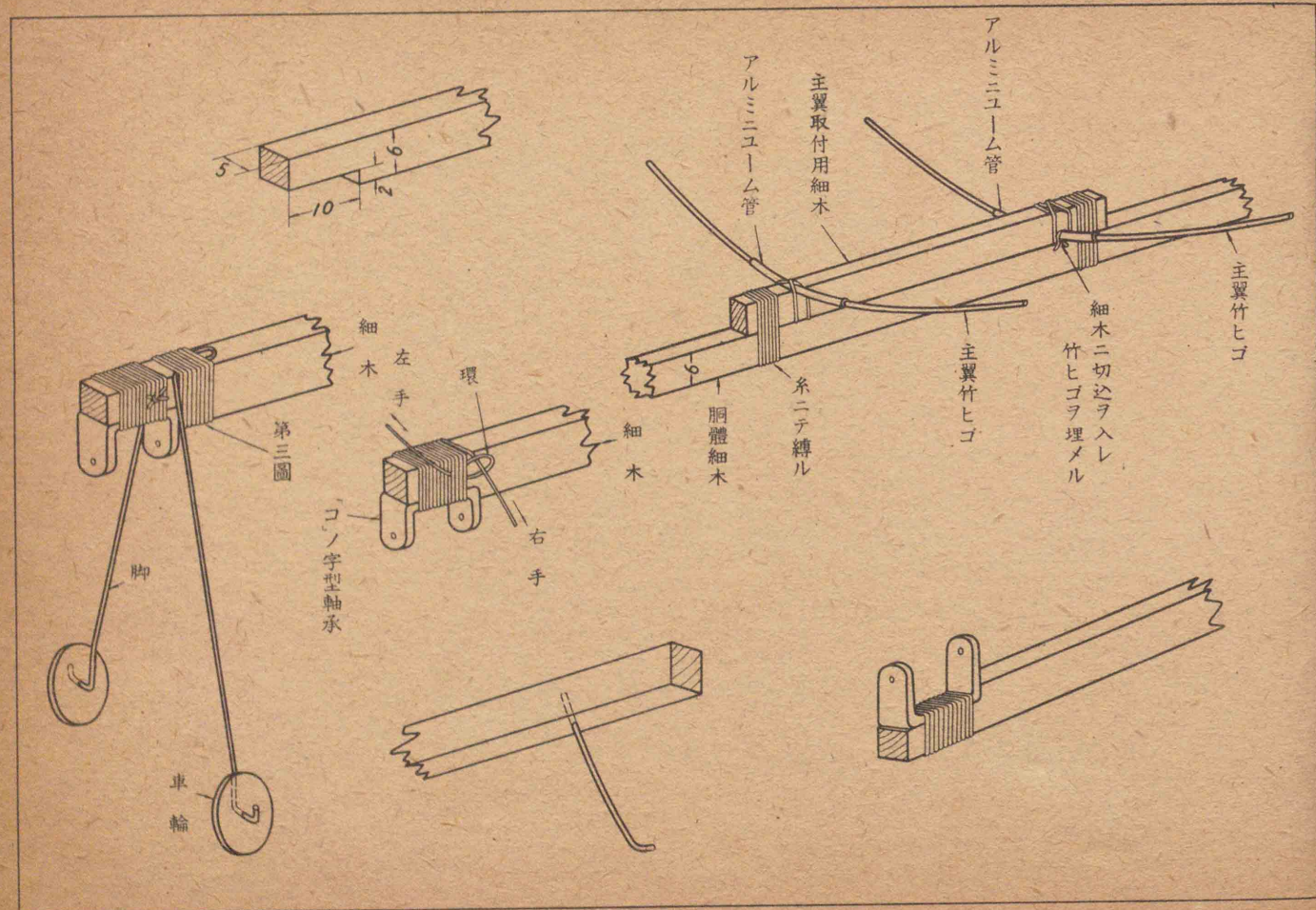

飛行機 ソノ五

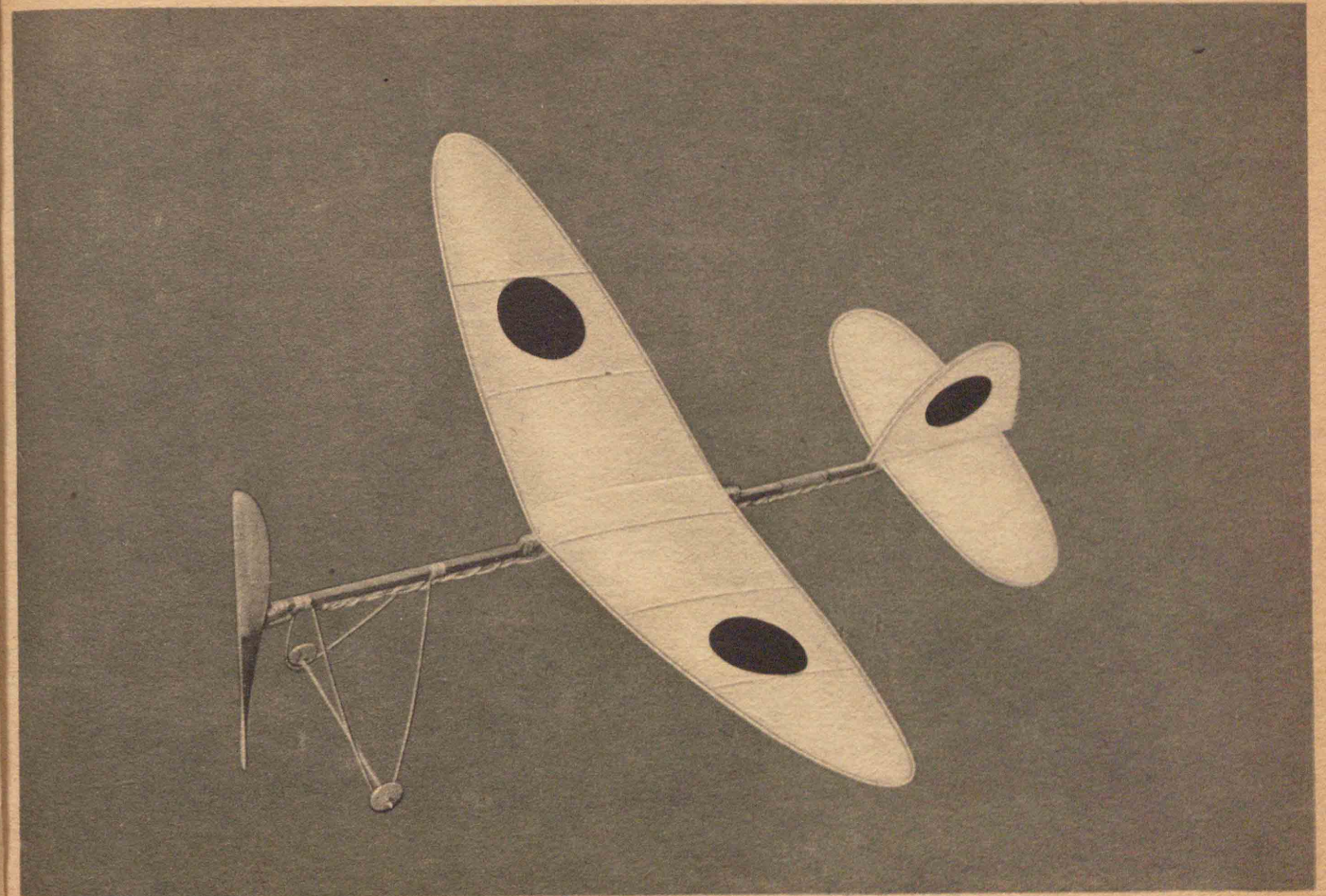

飛行機 ソノ六

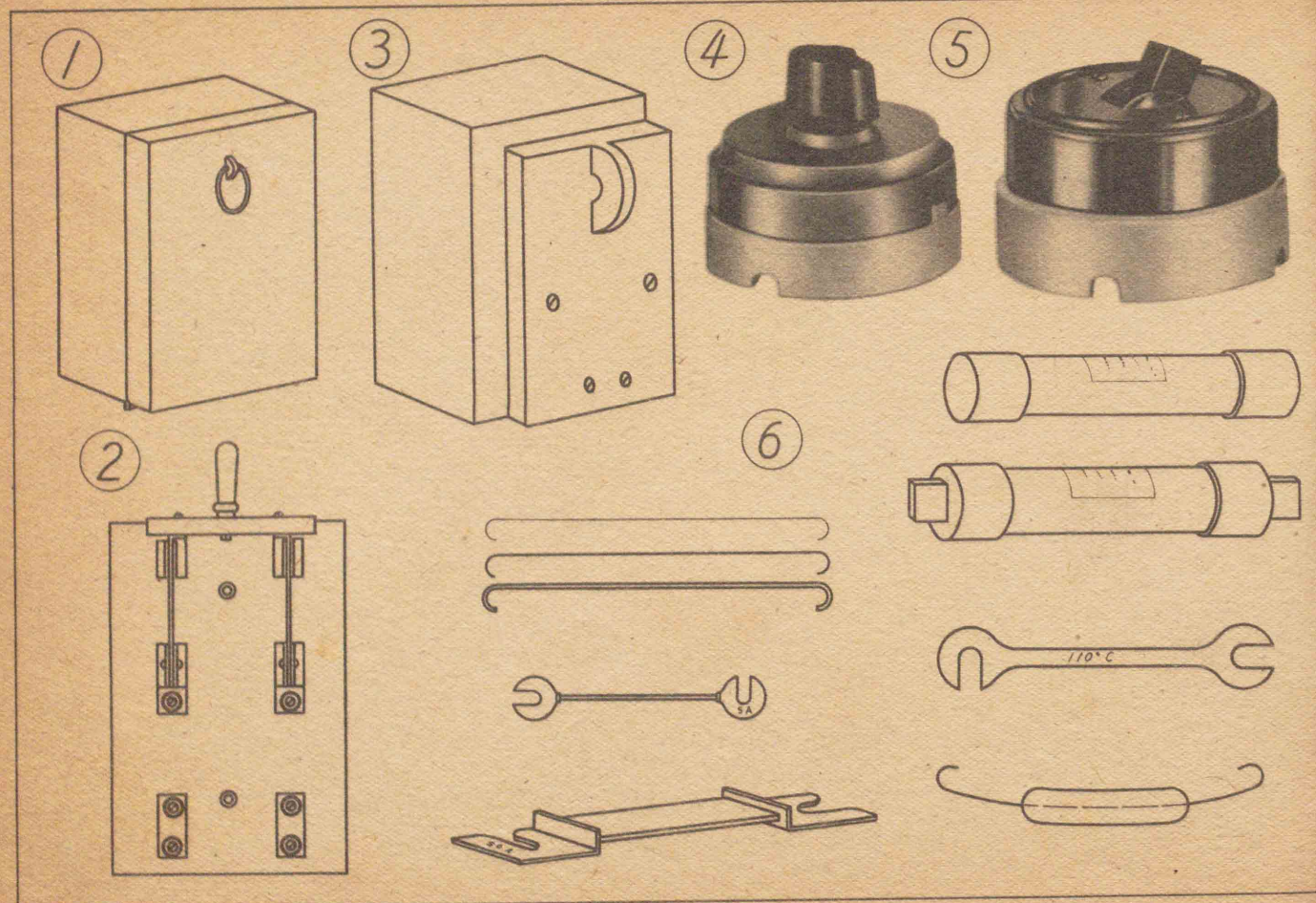

7. 電氣器具ノ扱ヒ方 ソム-

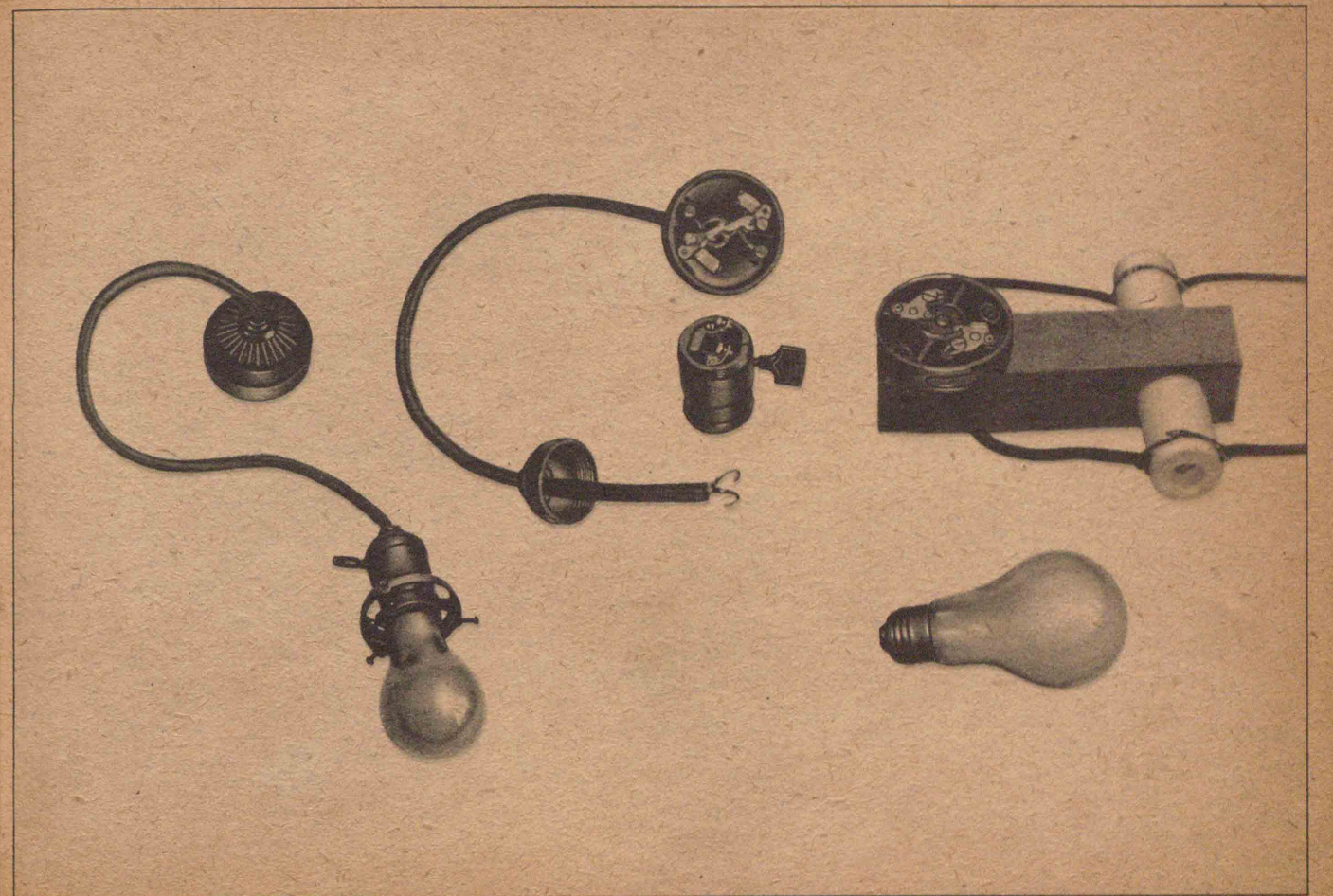

電氣器具ノ扱ヒ方 ソノニ

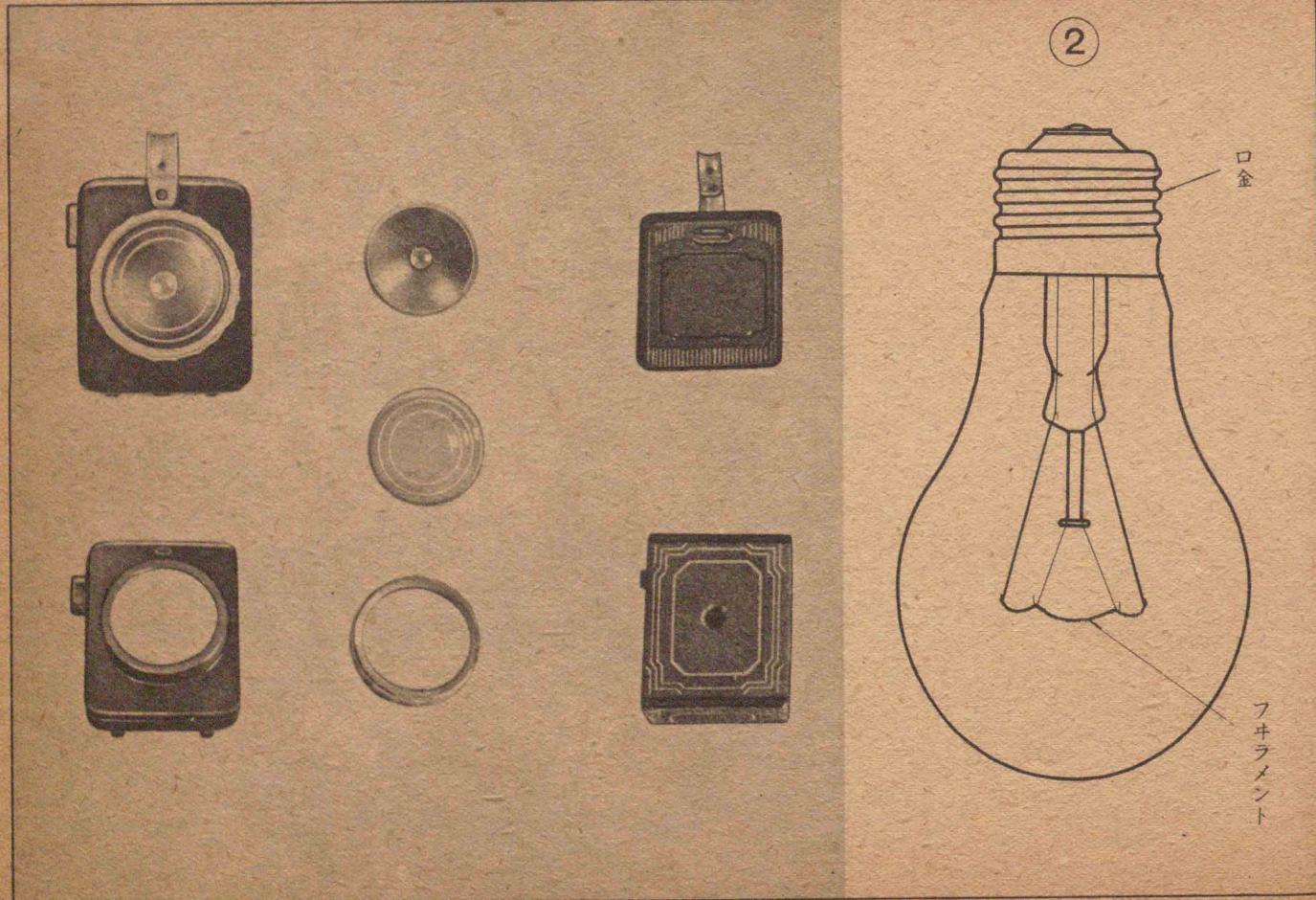

電氣器具ノ扱ヒ方 ソノ三

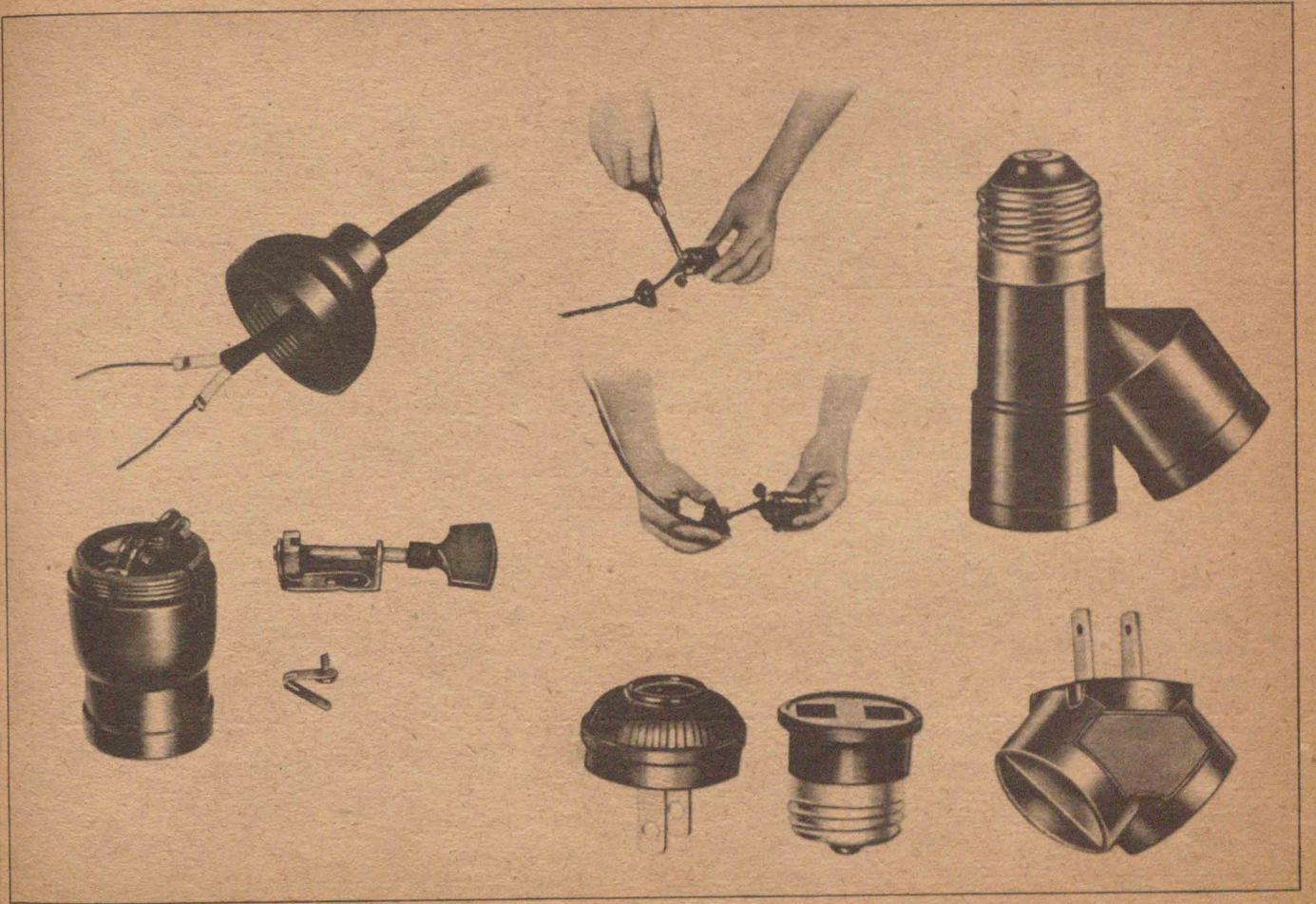

電氣器具ノ扱ヒ方 ソノ四

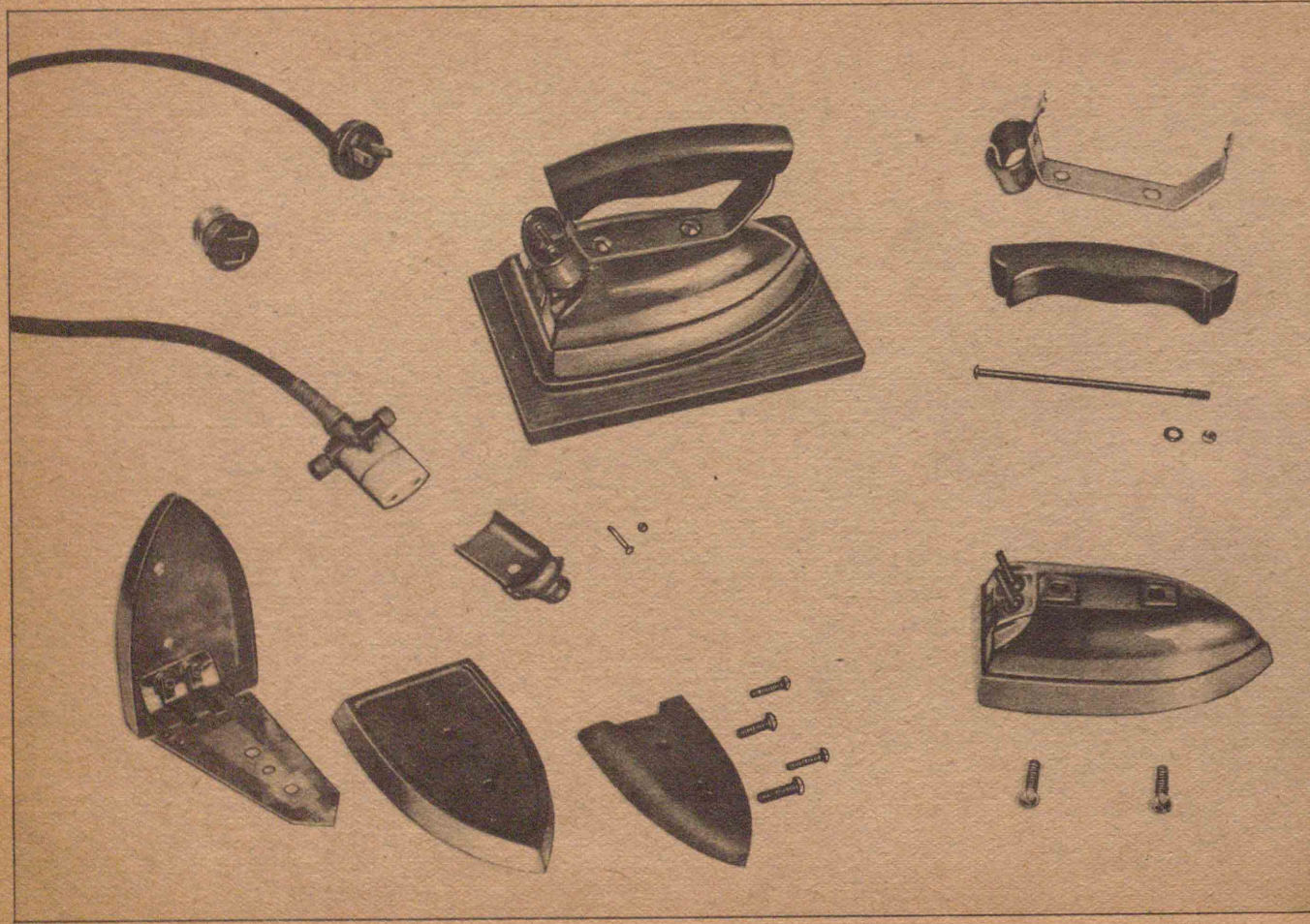

電氣器具ノ扱ヒ方 ソノ五

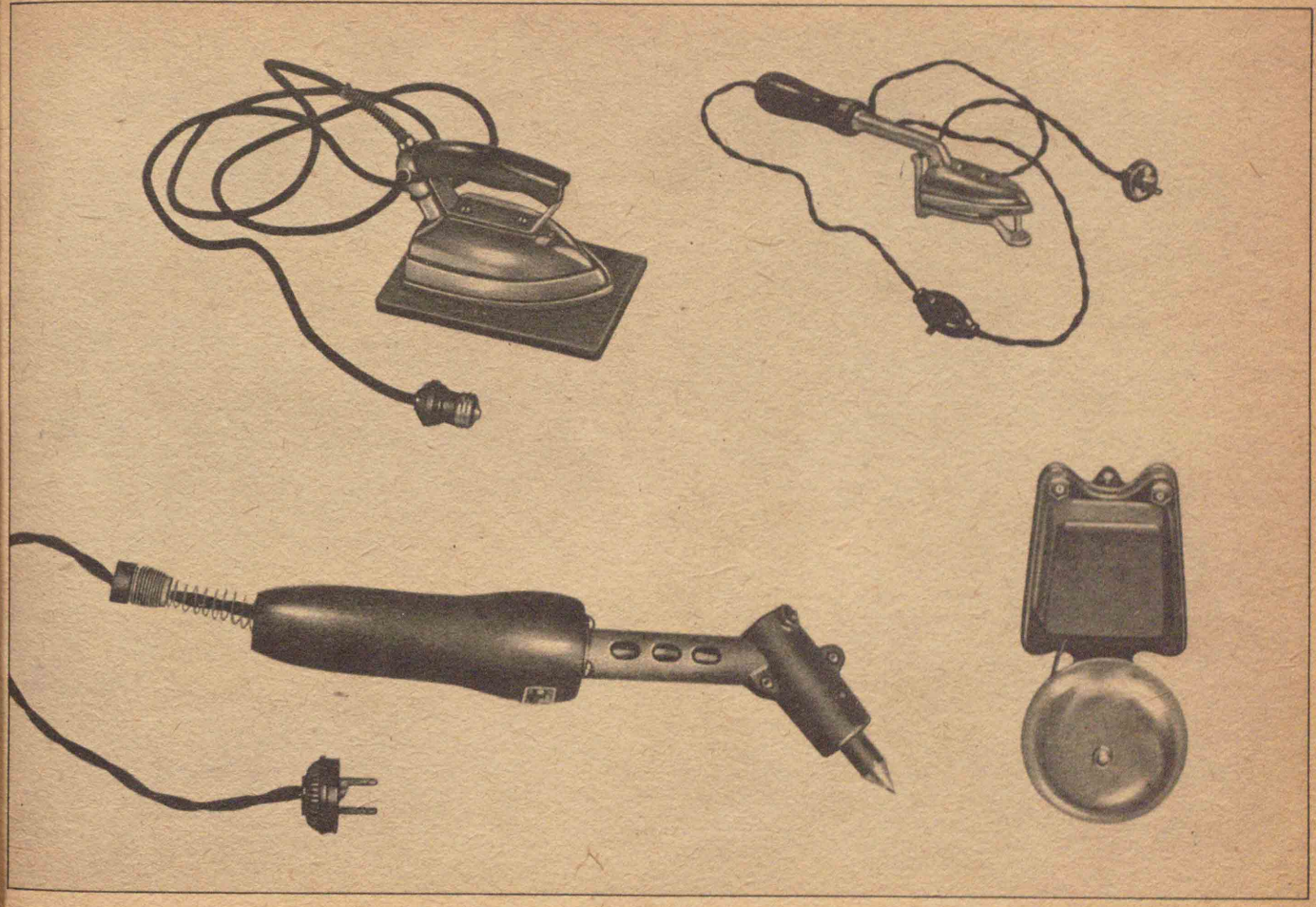

電氣器具ノ扱ヒ方 ソノ六

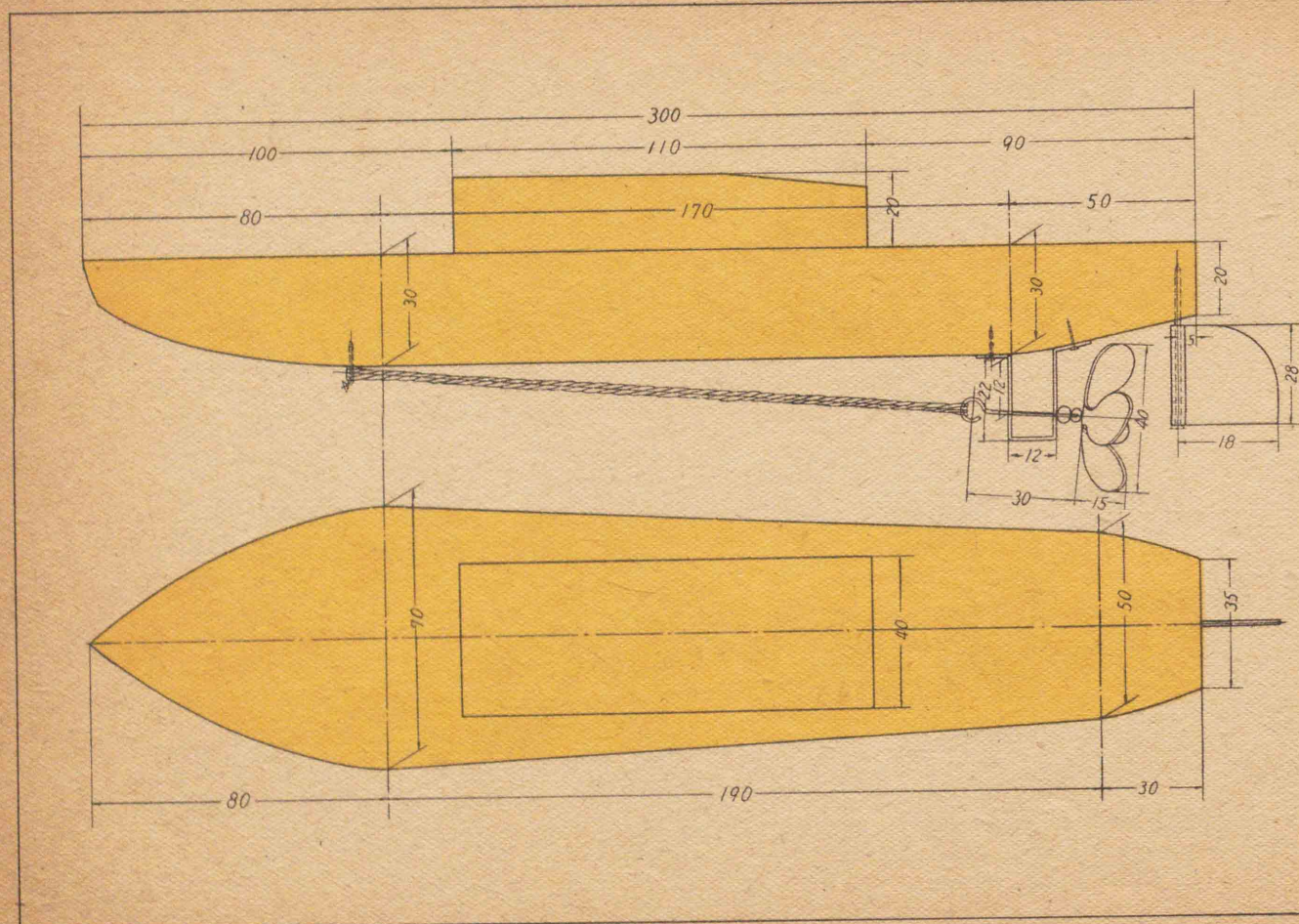

8. 舟 ソノー

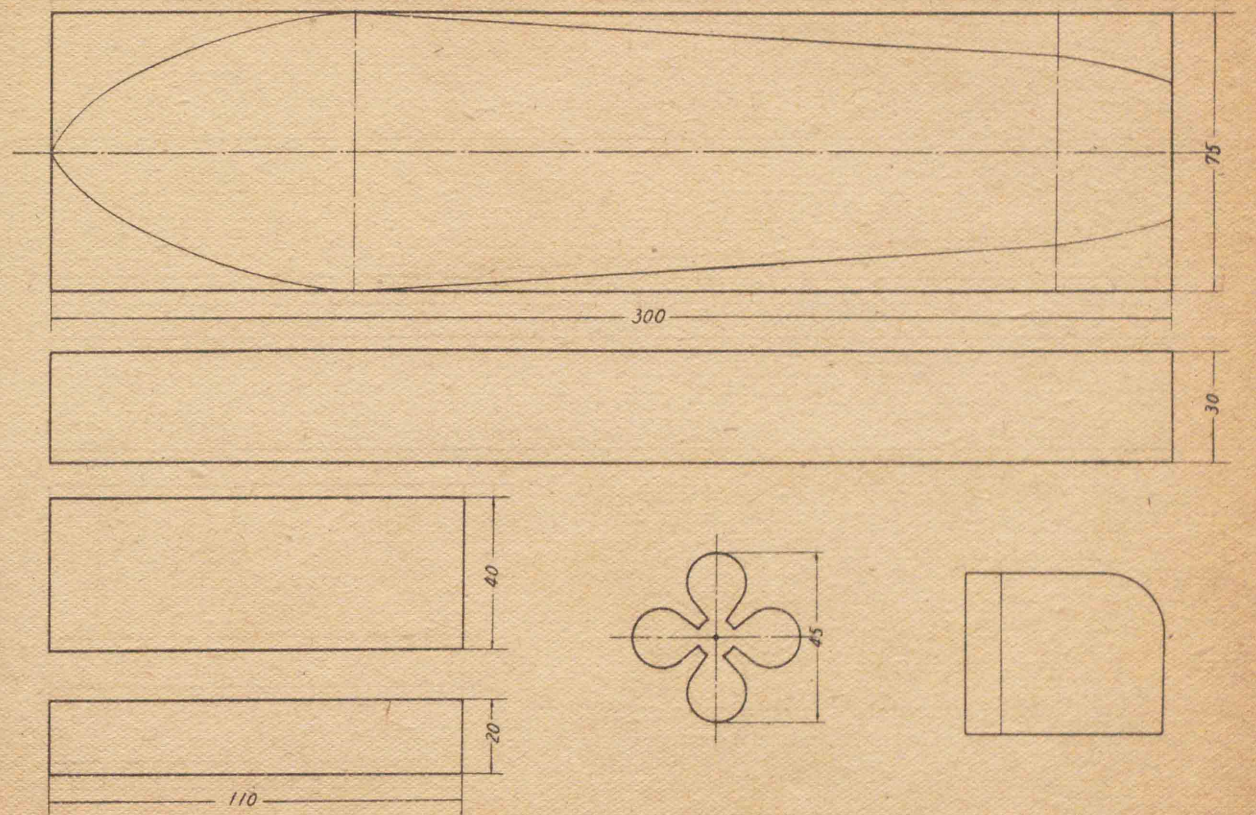

舟 ソノニ

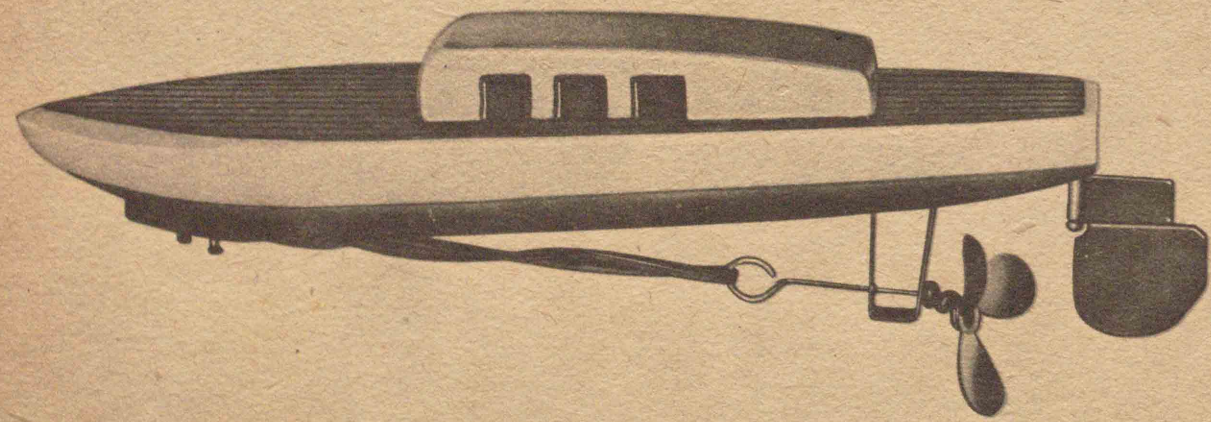

舟 ソノ三

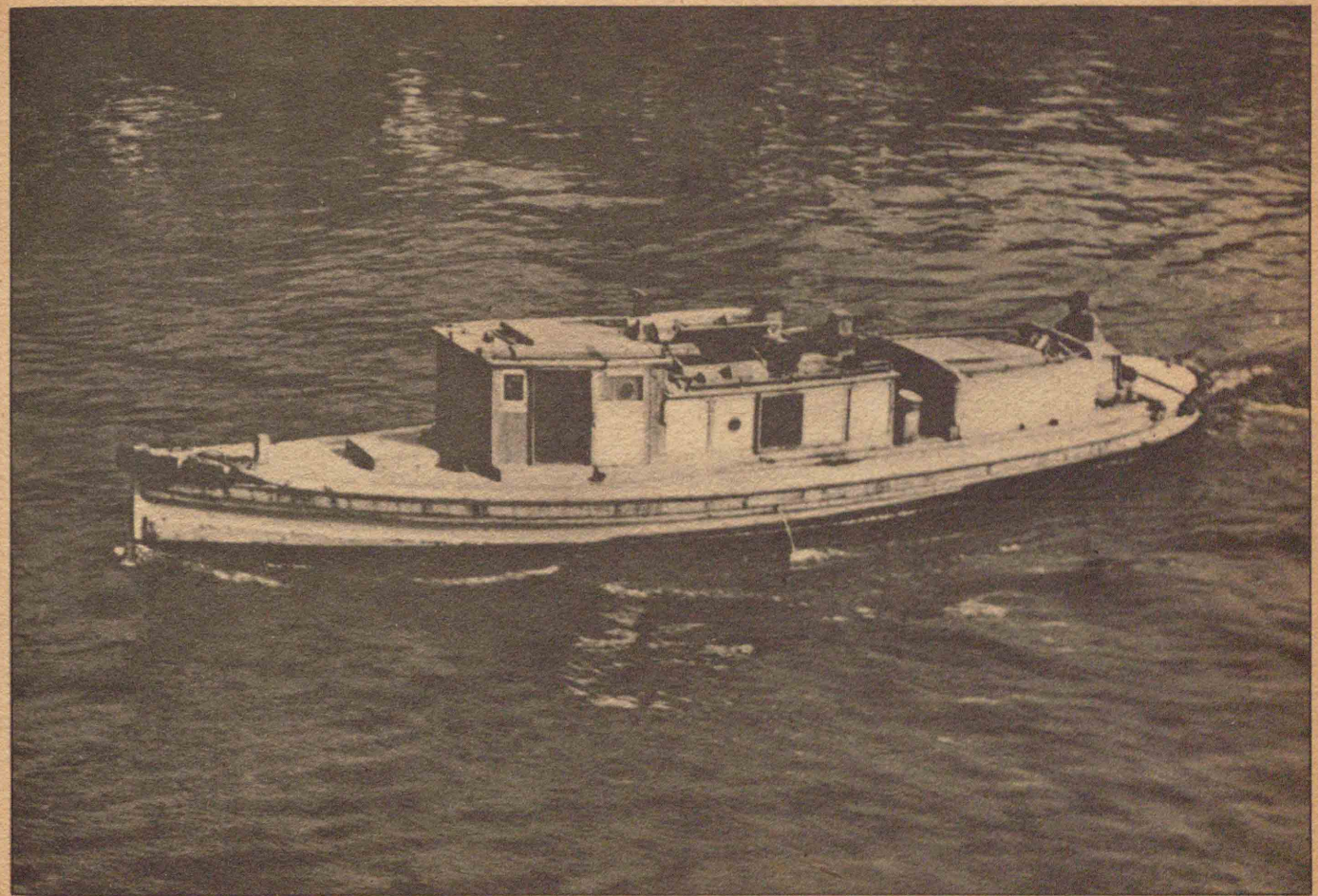

舟 ソノ四

鎖編

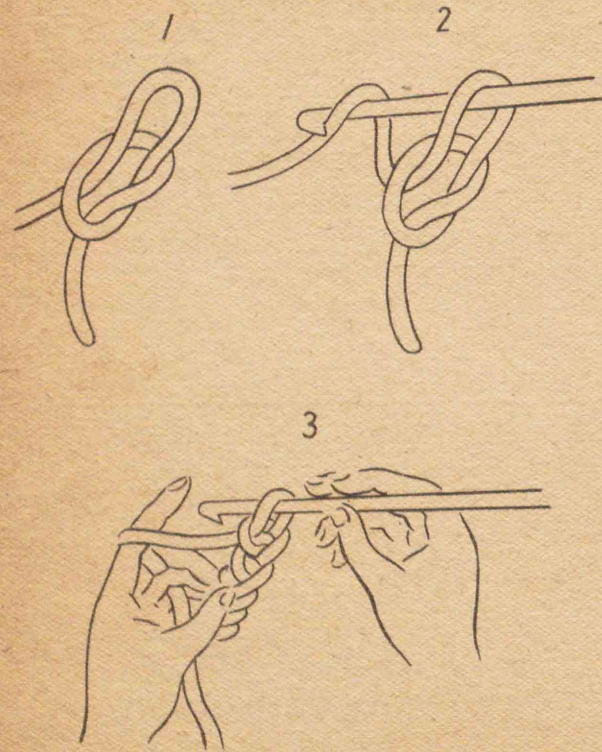

短編

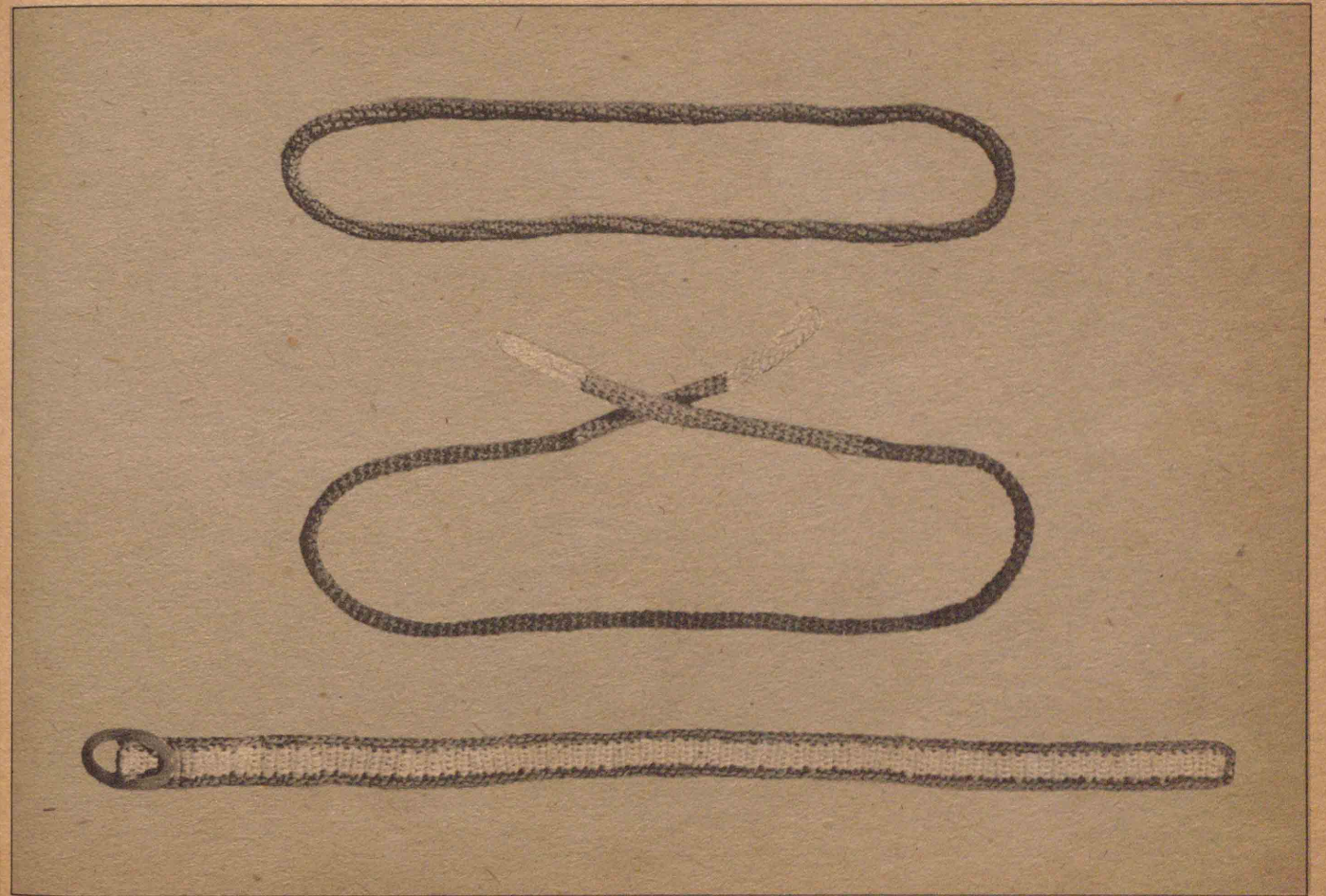
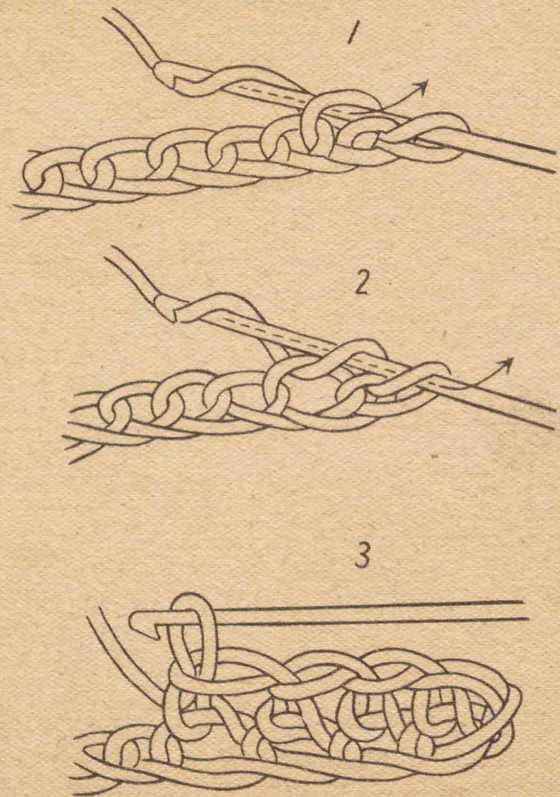

引拔キ編

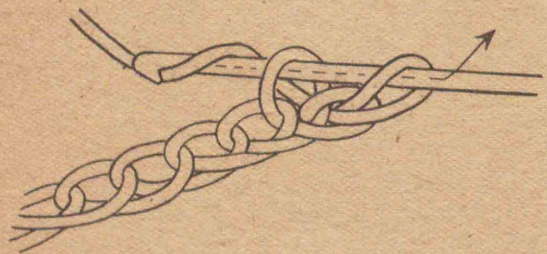

2

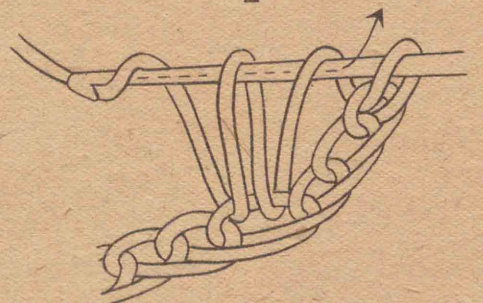

長編

1

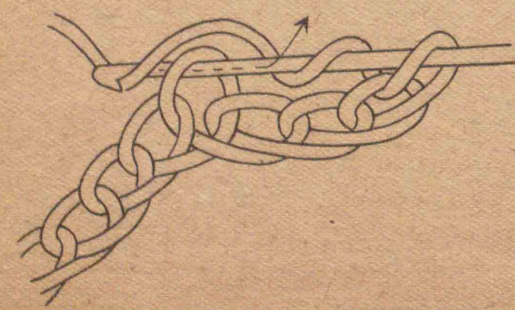

3

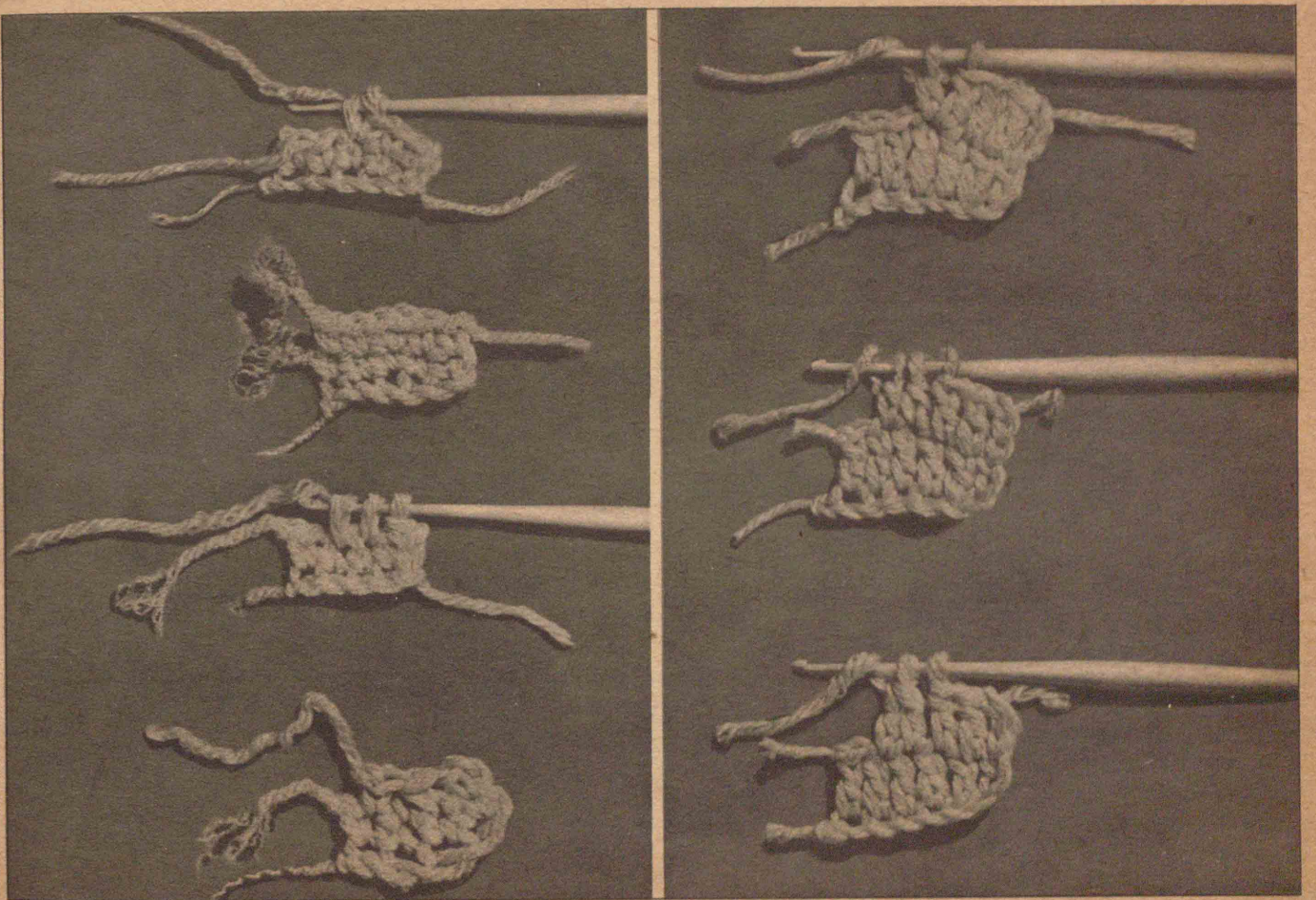
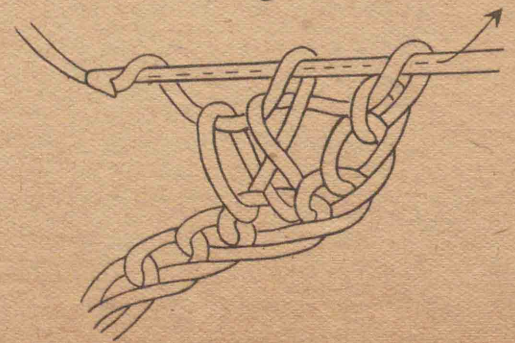

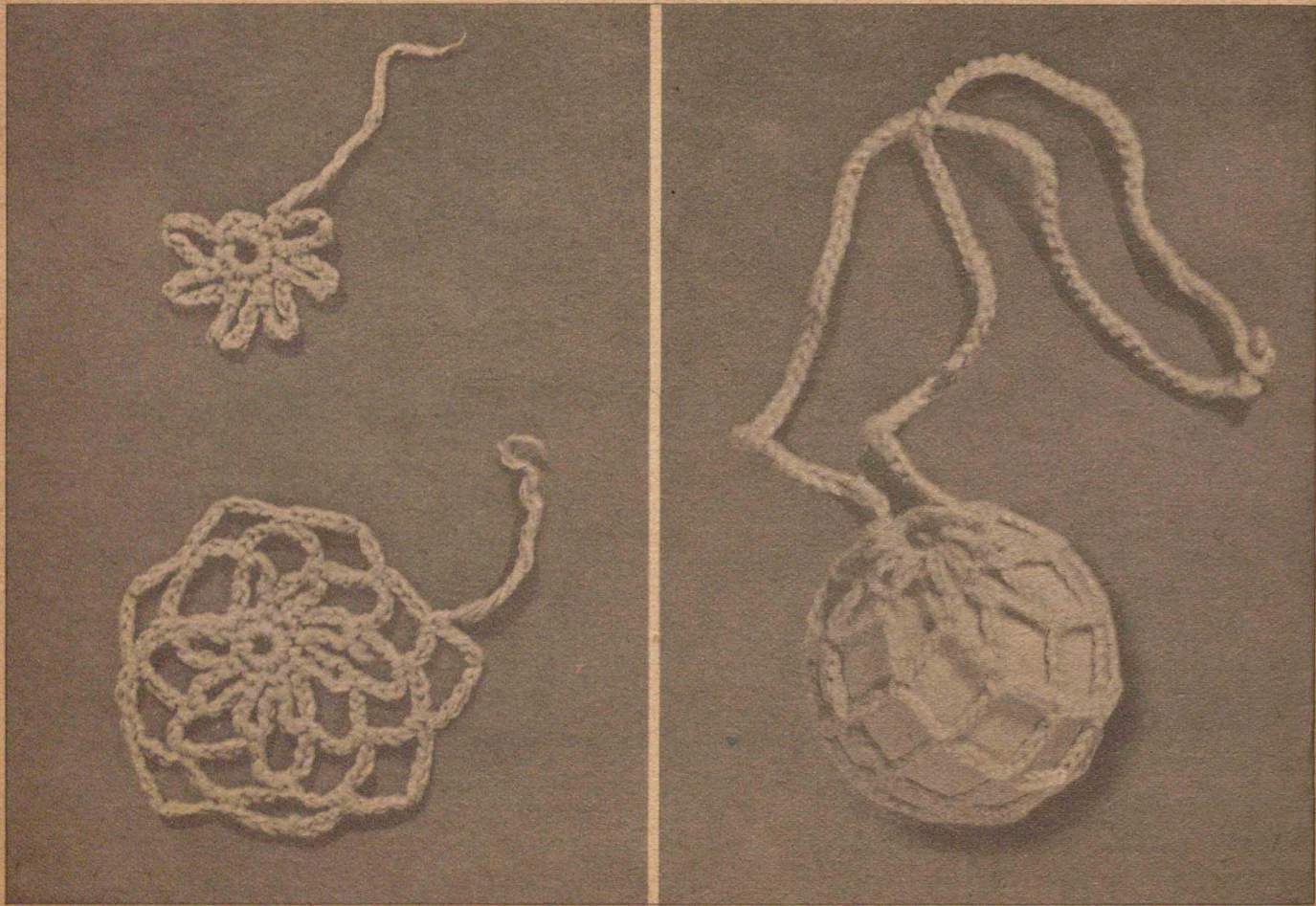

辨當袋 ソノ三

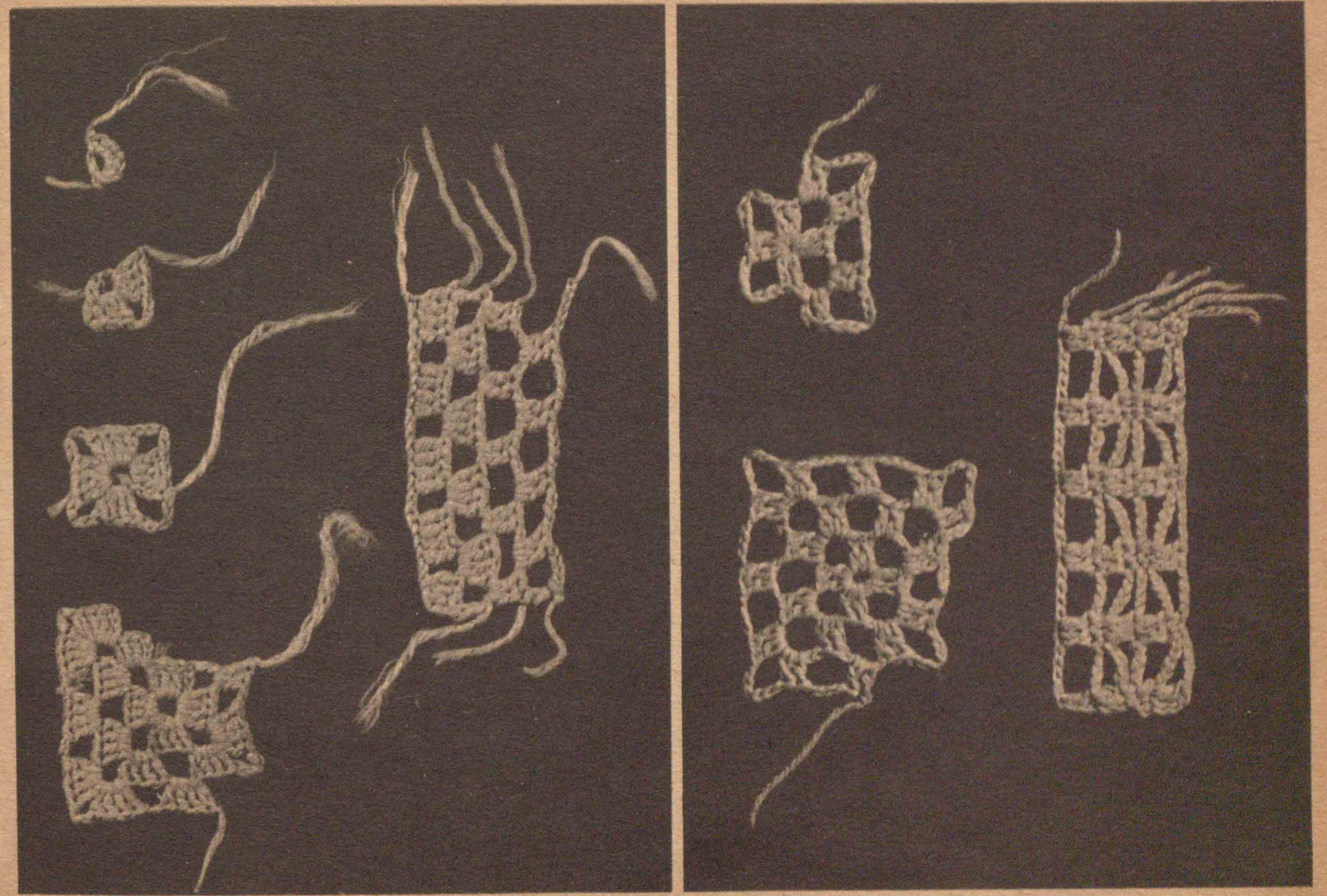

辨當袋 ソノ四

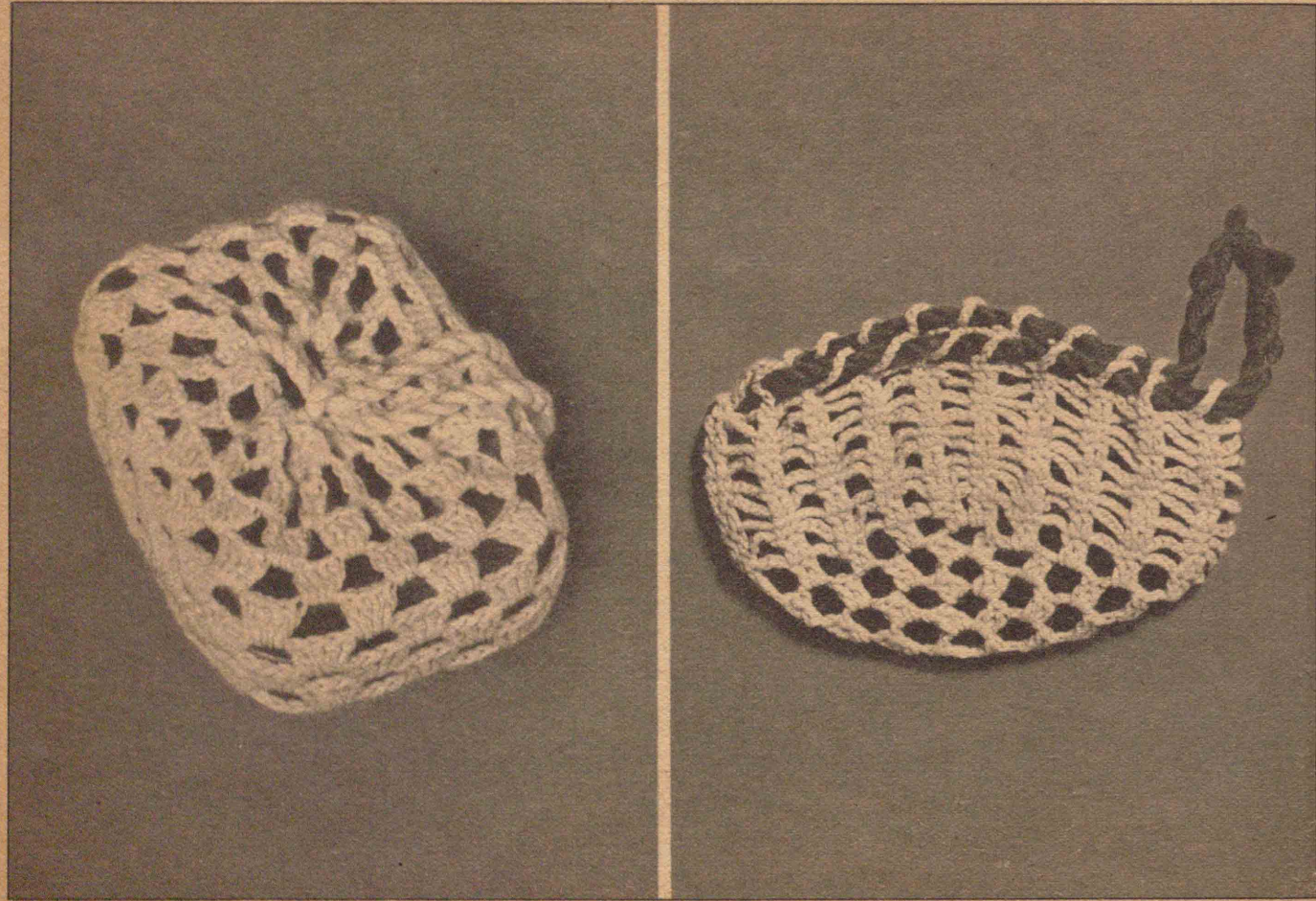

辨當袋 ソノ五

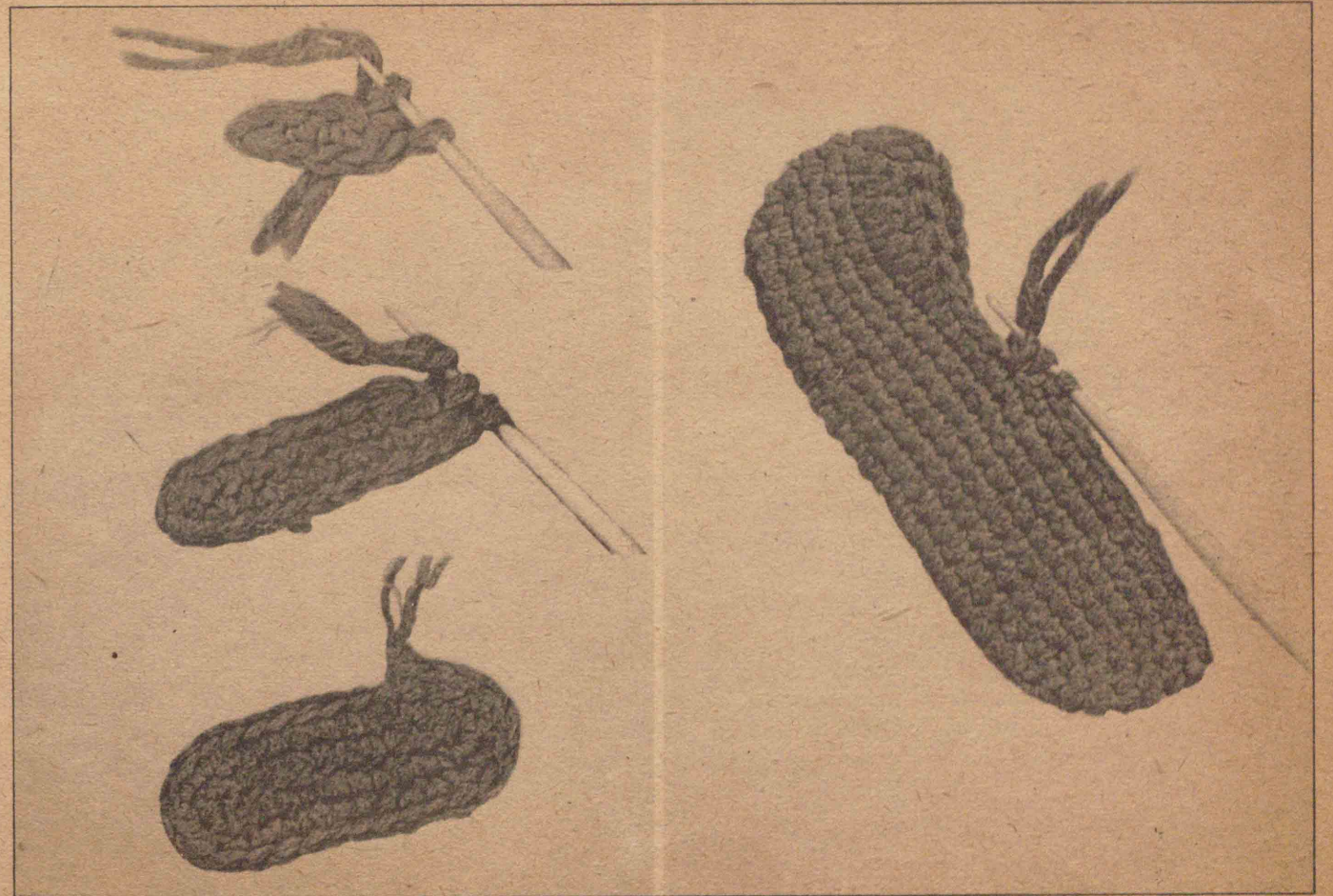

11. 靴下カバー ソノー

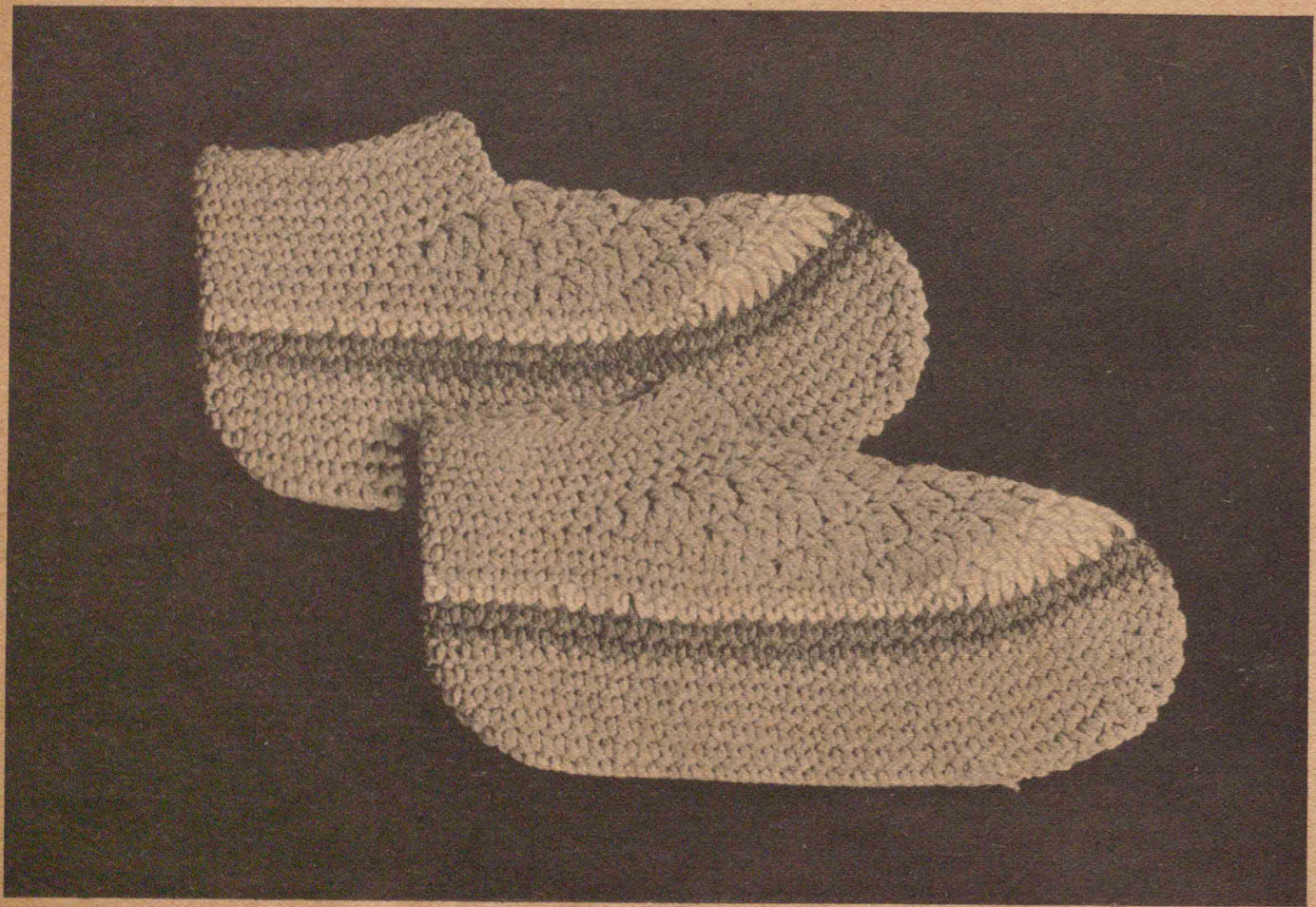

靴下カバー ソノニ

昭和十八年三月九日
文部省検査済



發行所

東京書籍株式會社

印刷所 凸版印刷株式會社
東京市下谷區二長町一番地

兼印刷者 代表者 井上源之丞
翻刻發行 東京書籍株式會社
東京市王子區堀船町一丁目八百五十七番地

著作權所有

發行兼
著作者

文 部 省

昭和十八年三月廿三日
昭和十八年三月八日
昭和十八年三月八日
昭和十八年三月六日

翻刻發行
翻刻印刷
發行
印刷

新 定價金拾七錢

初等科工作三女子用わ

